

Connectivity

Infrared	10-2
Before Using Infrared.....	10-2
One/Multiple File Transfer	10-3
All File Transfers.....	10-3
IC Transmission	10-4
One File Transfer.....	10-5
All File Transfers.....	10-5
Bluetooth®	10-6
Before Using Bluetooth®	10-6
Using Bluetooth®	10-7
Suspending Bluetooth® Functions	10-8
Placing Bluetooth® Devices on Standby for Connection.....	10-9
Sending/Receiving Phone Book	10-9
Bluetooth® Functions.....	10-10
SoftBank Utility Software (Japanese)	10-11
USB (Japanese)	10-11
Setting USB Mode	10-11
Transferring Data via USB Cable.....	10-11
Data Communication via USB Cable.....	10-12
AV Output	10-13
Connecting Handset to TV	10-13

Infrared

Before Using Infrared

Transfer Phone Book/Calendar events, messages, bookmarks and Data Folder files wirelessly between 931P and compatible devices, including PCs and other mobiles.

- 931P infrared function is based on IrMC1.1, however, some IrMC1.1-based device transmissions may not be transmitted/received within specification.
- Debris may inhibit infrared transfers; clean infrared ports with a soft cloth beforehand.
- Direct sunlight/fluorescent light may inhibit transfers.
- Align infrared ports within 20 cm of one another and make sure no objects are placed between them. Do not move the devices until transfer is complete.

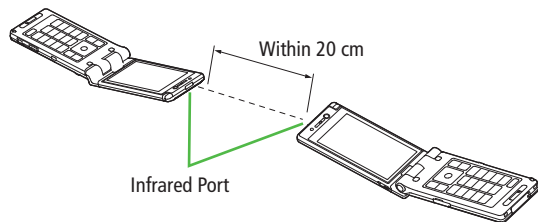

Transferable Files

Transferable file	Condition	One file	All files
Phone Book (Account Details)		○	Up to 1000
Calendar events ¹		○	Up to 1000
Tasks		○	Up to 100
Received message		○	Up to 3000
Sent message		○	Up to 1000
Drafts		○	Up to 10
Notepad		○	Up to 20
Ring Songs&Tones		○	—
Still image ^{2 3}		○	—
Video ³		○	—
Bookmark (Yahoo! Keitai, PC Site Browser)		○	Up to 100 each
Widget ³		○	—

○: Transferable —: Not transferable

¹ Saved Holidays/Memorial days not transferable

² Including Flash[®] files

³ Multiple files transferable

Note

- Following files cannot transfer:
 - Files prohibited for transfers from 931P
 - Phone Book entries and SMS on USIM Card
- If memory becomes full, remaining entries are truncated (Memory List: [P.19-25](#)).

One/Multiple File Transfer

- Transferable Files: P.10-2

Sending

- 1 Highlight a file, and follow the steps below

Files to Send	Operation/Description
Phone Book	> [Menu] → <i>Send Ir data</i> → <i>Send phonebook</i>
Account Details	> [Ir]
Messages	> [Menu] → <i>Send Ir data</i> → <i>Send This</i>
Bookmarks	> [Menu] → <i>Send to ExtnrIDvcs</i> → <i>Send Ir data</i> → <i>Send This</i>
Still Images/ Videos/ Widgets	> [Menu] → <i>Send Ir data</i> ● To send multiple files: [Menu] → <i>Multiple-choice</i> → Select files to send → [Menu] → <i>Send Ir data</i>
Other Files	> [Menu] → <i>Send Ir data</i>

2 YES

Receiving

Main Menu ► Tools ► Receive via Infrared ► Receive

- 1 When a file is received, **YES**
Send files from sender side within 30 seconds.
 - To receive subsequent files, select **YES**.

All File Transfers

Precaution

- Receiving all files overwrites all saved files including secret/protected files.
Files saved in Secret Mode are also deleted.
- Sending all Phone Book entries sends Account Details as well.
User-edited information is overwritten (handset number remains).

Session Number

Session number (4 digits) is required for all file transfers via Infrared and IC transmission. Sender and recipient must enter same Session number to complete transfers.

Sending

- 1 Highlight a file, and follow the steps below

Files to Send	Operation/Description
Phone Book	[Menu] → <i>Send Ir data</i> → <i>Send all phonebook</i>
Messages	[Menu] → <i>Send Ir data</i> → <i>Send All</i>
Bookmarks	[Menu] → <i>Send to ExtnrIDvcs</i> → <i>Send Ir data</i> → <i>Send All</i>
Other Files	[Menu] → <i>Send all Ir data</i>

- 2 Enter Phone Password → Enter Session number → **YES**
Recipient must enter the same Session number to start transfers.

Receiving

Main Menu ► Tools ► Receive via Infrared ► Receive All

- 1 Enter Phone Password → Enter same Session number as sender's → **YES** → **YES**
Saved files are deleted, and transfer starts.

IC Transmission

Exchange files with another IC compatible handset using reader/writer function.

- Type of files and transfer conditions are same as those for infrared file transfer (☞P.10-2).
Multiple file transfer is not available.
- IC transmission is not available when **IC Card Lock** (☞P.16-5) is activated.
- When receiving data, end all active functions.
- If there is difficulty in file transfer, move a  logo close to or away from the other logo or move each side up, down, left, or right.
- Data cannot be sent during charging battery.

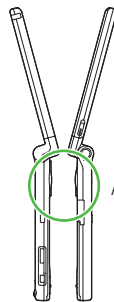

Align  logos of both handsets

One File Transfer

Before Receiving a File

- **Receive IC Datum** is set to **ON** by default. When **Receive IC Datum** is **OFF**, One File Transfer is unavailable.
- To set **Receive IC Datum** on:
Main Menu ► **Osaifu-Keitai** ► **IC Card Settings**
► **Receive IC Datum** ► **ON**

Sending

- 1 Highlight a file, and follow the steps below

Files to Send	Operation/Description
Phone Book	> [Menu] → <i>IC transmission</i> → <i>Send phonebook</i>
Account Details	> [ICtrans]
Messages	> [Menu] → <i>IC Transmission</i> → <i>Send This</i>
Bookmarks	> [Menu] → <i>Send to ExtrnDvcs</i> → <i>IC transmission</i> → <i>Send This</i>
Other Files	> [Menu] → <i>IC transmission</i>

2 YES

Receiving

- 1 Align  logo on sender side with 931P (recipient) → **YES**

All File Transfers

- Precautions/Session number (P.10-3)

Sending

- 1 Highlight a file, and follow the steps below

Files to Send	Operation/Description
Phone Book	> [Menu] → <i>IC transmission</i> → <i>Send all phonebook</i>
Messages	> [Menu] → <i>IC Transmission</i> → <i>Send All</i>
Bookmarks	> [Menu] → <i>Send to ExtrnDvcs</i> → <i>IC transmission</i> → <i>Send All</i>
Other Files	> [Menu] → <i>All IC transmission</i>

- 2 Enter Phone Password → Enter Session number → **YES**
Recipient must enter the same Session number to start transfers.

Receiving

- 1 Align  logo on sender side with 931P (recipient)
- 2 **YES** → Enter Phone Password → Enter same Session number as sender's
Saved files are deleted. Transfer starts.

Bluetooth®

Connect handset to Bluetooth® devices to use functions below.

Function	Device	Description
Handsfree Calls (☞P.10-10)	Headsets Handsfree devices	Talk handsfree on handset
Wireless Playback (☞P.10-10)	Audio devices	Play back sounds (Digital TV/ Video) or music (Music Player) wirelessly from external speaker
Internet Connection (☞P.10-10)	PC	Connect wirelessly to Internet using handset as external modem
Sending/Receiving Phone Book (☞P.10-9)	PC Handsets	Send/receive Phone Book entries wirelessly

Tip

Settings

- Stop Ringtone Output to Headset/Handsfree Device
- Continue Calls on Handset when Bluetooth® is Disconnected from Headset/Handsfree Device
- Always Make Calls from 931P even when Headset is Connected
- Always Use Handsfree Device to Make/Receive Calls (☞P.18-17)

Before Using Bluetooth®

Bluetooth® Specifications

Version	Bluetooth® specification Ver.2.0+EDR
Supported Profiles ¹	HSP (Headset Profile) HFP (Hands-Free Profile) A2DP: Advanced Audio Distribution Profile AVRCP: Audio Video Remote Control Profile DUNP: Dial-up Networking Profile OPP (Object Push Profile)
Output	Bluetooth® Power Class2
Frequency Bands ²	2.4GHz (2.402GHz-2.480GHz)
Communication Distance ³	Approximately ten meters

¹ Bluetooth® connections are available with compatible devices supporting the same profile.

² Bluetooth® operates in the 2.4 GHz unlicensed frequency band. Depending on other devices in use in the spectrum, Bluetooth® connection may slow down/terminate, or range may decrease.

³ Affected by distance between devices, obstructions, signal conditions, handset status, etc.

Notes

- 931P may not be able to establish a Bluetooth® connection with some Bluetooth® devices.
- Establish connections with certified Bluetooth® devices that meet the specification standards developed by Bluetooth® SIG.
- Due to the unique characteristics/specifications of a certified Bluetooth® device, connections or transfers may fail; procedures, displayed results or operations may vary from those described in the manual.
- When data transfer is interrupted, it may take some time for process to complete.
- Noise may interfere with wireless or handsfree conversations depending on the status of connected devices or signal conditions.
- For details about headset/handsfree devices, see the device manuals.

Using Bluetooth®

Pair Bluetooth® devices with 931P beforehand to establish connections for different Bluetooth® functions.

Searching & Pairing Devices

Search other Bluetooth® devices.

Paired devices appear in Search&Paired Device list.

- Bluetooth® Passkey is not necessary for paired devices.
- Search up to 20 Bluetooth® devices at one time; pair with up to ten Bluetooth® devices.
- Place Bluetooth® devices on standby for connection.

Main Menu ▶ Tools ▶ Bluetooth ▶ Search&Paired Device

1 **YES***

Device search starts and names of found devices appear.



- To search again:  [Search]



* If there are already paired devices in list, select a device → Select a function

2 Select a device → **YES** → Enter Phone Password

3 Select text entry field → Enter Bluetooth® Passkey

4 Select a Bluetooth® function

931P connects to Bluetooth® device. When complete,  flashes in blue. After no Bluetooth® connection is made for a certain time,  appears in black and Power saver mode starts.

- When Bluetooth® device can connect to multiple services, confirmation appears asking whether to connect to another service.
- While connected,  (Blue) appears. While in Standby,  (Gray) appears.
- When **Dial-up** is selected, 931P stands by for connection requests from other Bluetooth® devices.
- **Dial-up** can be selected regardless of profile types.

Bluetooth® Passkey

Bluetooth® Passkey (1 to 16 digits) is required to connect Bluetooth® devices; sender and recipient must input the same code to complete file transfers.

- Bluetooth® Passkey is not necessary for paired devices.

Search&Paired Device List

1 Device Type

Indicators appear for different types of devices.

2 Device Name

Device names appear.
When no names are found, Bluetooth® addresses appear.

3 Connection Status

: Connected : Not connected : Not found : Not paired

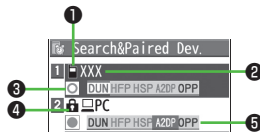

Search&Paired Device

4 Protection

Indicator appears when registered contents are protected.

5 Profile Status

Indicators appear to show profile status.

Icon	Letter Color	Background Color	Frame Color	Status
	Blue	Gray	–	Not connected (Not paired)
	Blue	Gray	Blue	Not connected (Paired)
	White	Green	–	Connected
	Green	White	Green	Standby for connection
	White	Light green	–	Preferred device
	Gray	Gray	–	Not supported

Tip

Settings ● Set Duration to Search for Bluetooth® Devices (P.18-17)

Suspending Bluetooth® Functions

Suspend all Bluetooth® functions connected or on standby for connection, and disable Bluetooth®.

Main Menu ► Tools ► Bluetooth

1 Bluetooth OFF → YES

- To return to standby for previously connected function:
Bluetooth ON

Placing Bluetooth® Devices on Standby for Connection

Main Menu ► Tools ► Bluetooth ► Accept Registered

- 1 Check functions to be on standby for connection →
☑ [Finish]
 - To uncheck, select functions to remove check marks.

Sending/Receiving Phone Book

Sending

- 1 Open Phone Book → ☰ [Menu] →
Send to Bluetooth
- 2 **One File Transfer**
Send phonebook → Select a recipient device
All File Transfer
Send all phonebook → Select a recipient device →
Enter Phone Password
- 3 **YES**

Receiving

Main Menu ► Tools ► Bluetooth ► Receive via Bluetooth

- 1 **One File Transfer**
Receive → **YES**
All File Transfer
Receive All → Enter Phone Password → **YES** → **YES**
 - If memory becomes full, remaining entries are truncated (Memory List: ↗P.19-25).

Tip

Settings

- Set Authentication/Encryption to Send Phone Book Entries
- Enter Password when Sending All Phone Book Entries (↗P.18-17)

Bluetooth® Functions

From ► **Main Menu** ► **Tools** ► **Bluetooth**

■ Functions Available in Search&Paired Device Window

> **Search&Paired Device** →  [Menu] → Select an item (See below)

Item	Operation/Description
Register devices	> Enter Phone Password → Pair devices (☞ From Step 3 on P.10-7)
Preferred device	Set a preferred Bluetooth® device for incoming calls <ul style="list-style-type: none"> ● Available only for headset function compatible Bluetooth® devices. ● To cancel, perform same operation.
Protect/release	Protect/cancel devices. Protection prevents devices from being deleted or overwritten
Change device name	> Enter a device name
Delete	> YES
Description	Show device name, Bluetooth® address, device class and supported profile
Add shortcut icon	Create shortcuts (☞ P.1-22)

■ Make/Receive Calls via Bluetooth®

> **Search&Paired Device** → Select a device → **Headset** or **Hands-free**
→ **YES** → Make/receive a call using Bluetooth® device

■ Use Bluetooth® Device for Wireless Playback

> **Search&Paired Device** → Select a device → **Audio** → Watch Digital TV or play back videos or music

- Digital TV/Video sounds are played only by A2DP profile compatible Bluetooth® devices compliant with SCMS-T copyright protection standard.

■ Connect to Internet Using Bluetooth® Device

> **Search&Paired Device** → Select a device → **Dial-up**

- 931P waits for dial-up connection.
- Refer to a manual for Bluetooth® device for details.
Download utility software (931P) "Modem Wizard" from website below to PC and install software.
<http://panasonic.jp/mobile/support/download/931p/index.html>
- To establish a dial-up connection, see Help on "Modem Wizard."
- Connecting handset to a PC or PDA for Internet access may incur high packet transmission charges.

■ Place Bluetooth® Device on Standby for Dial-up

> **Dialup Rgstry Standby** → Enter Phone Password → **YES** → Select Bluetooth® Paskey text box → Enter Bluetooth® Passkey

SoftBank Utility Software (Japanese)

Phone Book, Calendar, Tasks, messages, Bookmarks, Notepads and Data Folder can be transferred to a PC, edited or managed by using SoftBank Utility Software.

- For details on and downloading SoftBank Utility Software, visit <http://mb.softbank.jp/r/utilitysoft/cd/> (Japanese)

Note

- USB cable (not included) is necessary for using SoftBank Utility Software.
- S! Appli, PC Movies, TV, Lifestyle-Appli, Books, Customized Screen, Templates and Other Documents cannot be backed up.
- Copy protected files may not be backed up.
- Set **USB Mode** to **Communication Mode** (☞Right).

USB (Japanese)

Connect 931P to a PC via USB cable (not included) specified by SoftBank for data transfer or data communication.

Setting USB Mode

<Default> Communication Mode

Main Menu ▶ Settings ▶ Connectivity ▶ USB Mode

- 1 Select an item (See below)

Item	Operation/Description
Communication Mode	Packet transmission, 64K data transmission, data transfer and calls with USB handsfree compatible devices are available (☞Left)
microSD Mode	Read/write data on microSD Card (☞P.9-21)
MTP Mode	Transfer/delete music data via Windows Media® Player on PC (☞P.8-4)

Transferring Data via USB Cable

- Transfer data using SoftBank Utility Software (☞Left).
- Transferring data in microSD Mode (☞P.9-21)

Data Communication via USB Cable

Use 931P as a modem for Internet access by connecting 931P with a PC.

- Download utility software from URL below and install on PC.
<http://panasonic.jp/mobile/support/download/931p/index.html>
- 1 Install "USB ドライバ (USB Driver)" and "Modem Wizard" from Utility Software (931P) to a PC
 - 2 Set 931P to **Communication Mode** (☞P.10-11), and connect 931P to PC via USB cable
 - Power up 931P before connecting to PC via USB cable.
 - 3 Start up "Modem Wizard", and operate communication setup
 - "Modem Wizard" enables you to set up APN and dial-up easily.
For setup/starting procedures, see "Modem Wizard" Help.

Note

- Connecting handset to a PC or PDA for Internet access may incur high packet transmission fees.

AV Output

View the following on a TV set or other devices using a SoftBank-specified video output cable (not included): Video Call images, Digital TV images, still images/videos saved on 931P.

- View AV-output-compatible S! Appli on TV.

Connecting Handset to TV

- To use video output cable (not included), Stereo Earphone Conversion Cable (not included) is required.

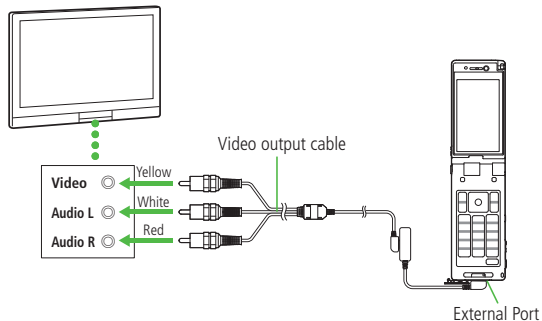

- 1 Open External Port Cover
- 2 Connect video output cable to handset using conversion cable
 - To connect video output cable to conversion cable: P.1-4

- 3 Connect video output cable to video/audio input terminal on TV set
- 4 Open an image file on 931P
 - To toggle display size:

Note

- Some images cannot be displayed on TV.
- Display size setting is not available for some TV sets.

10

Connectivity