

Content Search

Function/Service Name Search	Index	👉 P.19-27
	Contents	👉 P.vi
Objective Search	Objective Search	👉 P.ii
	Index	👉 P.19-27
Function Search	Overview	👉 P.iv
	Contents	👉 P.vi
Using Your Handset	Function List	👉 P.19-2
	Display	👉 P.1-10
Guide Organization	Contents	👉 P.vi
	Section Contents	👉 Chapter Top Pages
Solving Problems	Troubleshooting	👉 P.19-10
	Warranty & Service	👉 P.19-33

Getting Started	1
Call	2
Text Entry	3
Phone Book	4
Digital TV	5
Camera	6
Entertainment	7
Music Player	8
Managing Files	9
Connectivity	10
Handset Security	11
Tools	12
Messaging	13
Internet	14
S! Appli	15
Osaifu-Keitai®	16
S! GPS Navi	17
Settings	18
Appendix	19

Confirming & Using My Number & My Mail Address

My Phone Number

Confirm your phone number on 931P in Standby without navigating menus.

My Number:  P.1-30

My Mail Address

Customized address may reduce spam.

Customizing Handset Address:
 P.13-3

Customizing 931P Settings

Setting Ringtones

Set Chaku-Uta Full® files as ringtones.

Ringtones:  P.18-2

Downloading Tunes & Tones

Download music (Chaku-Uta Full®) files from mobile websites.

Downloading Music:  P.8-3

Mastering Basics



Learning Your Handset

Learn key assignments, and navigate menus to select & execute functions.

Handset Menus:  P.1-18
Parts & Functions:  P.1-4

Making Mobile Calls

Use voice telephony or enjoy video telephony with compatible mobiles.

Voice Calls:  P.2-2
Video Calls:  P.2-6

Fun Stuff

Watching One Seg Digital TV

Enjoy One Seg digital TV. Set channels in advance to view/record shows.

Digital TV:  P.5-1



Music Player

Download music files from websites via Music Player directly.

Music Player:  P.8-1



Sending Your Contact Info

Save mail address and other details; send to compatible devices wirelessly.

Account Details: ➡ P.4-13

Messaging Multiple Recipients

Enter multiple mail addresses/numbers to send a message to all at one time.

Sending Messages: ➡ P.13-4

Add/Edit/Delete Address: ➡ P.13-8

Sending Files Wirelessly

Send files or your own mail address saved in Account Details via Infrared/IC transmission to other compatible devices.

Infrared/IC Transmission: ➡ P.4-13

Customizing Standby Display

Add wallpaper, set clock size/position or set calendar to appear in Standby.

Wallpaper: ➡ P.9-7

Display: ➡ P.18-3, P.18-5

Customizing User Interface

Download applications that mimic the interface design of previously used handsets.

Familiar Usability: ➡ P.1-24

Using Shortcuts to Functions

Access shortcuts to frequently used functions in Standby.

Shortcuts: ➡ P.1-22

Mastering Text Entry Methods

Enter text for Messaging functions or to add/edit Phone Book entry items.

Text Entry: ➡ P.3-1

Using Messaging Services

Send short or long text messages. Attach image/sound files, etc. to S! Mail.

Messaging: ➡ P.13-1

Graphic Mail: ➡ P.13-5

Accessing the Mobile Internet

Access Mobile Internet sites via Yahoo! Keitai to browse sites or download files.

Yahoo! Keitai: ➡ P.14-2

Camera & Video Camera

Capture still images or record videos. Use Camera even when handset is closed.

Camera: ➡ P.6-1

Playing Games

Download and install S! Appli Games via Yahoo! Keitai.



S! Appli: ➡ P.15-1

Getting News (Japanese)

Set up S! Quick News to view a variety of information contents.

S! Quick News: ➡ P.7-4

931P Features**Horizontal Open Position**

Enjoy Digital TV, Messaging, S! Appli, Camera, etc. in wide horizontal screen. Key labels are adjusted horizontally.

👉 P.1-7

External Display

View information and capture images on External Display when handset is closed.

👉 P.1-23

SoftBank Mobile Features**Yahoo! Keitai**

Access Mobile Internet sites via Yahoo! Keitai to browse sites or download files.

👉 P.14-2

Graphic Mail

Create HTML messages; select font color/size, background; insert images.

👉 P.13-5

Useful Features**Phone Book/
S! Addressbook Back-up**

Save Phone Book entries; back up handset entries on Server, etc.

👉 P.4-1, P.4-10

Camera/Video

Capture still images or record videos with approx. 8.1 mega pixel camera. Set Image stabilizer/Face detection for high-quality pictures and videos.

👉 P.6-6, P.6-8

PC-related Functions**PC Site Browser**

View PC-based websites on 931P.

👉 P.14-5

Data Back-up/Management

Transfer data between handset and PC for back-up and editing.

👉 P.10-11

Digital TV

Enjoy One Seg digital TV programs and video in wide horizontal screen.

 P.5-1

Simple Menu

Use simplified menus limiting to only basic functions.

 P.1-26

Download Dictionary

Download specialized dictionaries. Dictionary words appear in character conversion suggestions.

 P.3-10

S! GPS Navi

Check your position on map, and navigate to a destination.

 P.17-1

S! Information Channel/Weather (Japanese)

Subscribe to content and periodically receive update information. Set Weather Indicator to check weather forecast in Standby.

 P.7-6

Mobile Widget (Japanese)

Download and paste widgets to Standby for quick access to information and various tools.

 P.7-2

Calendar & Alarm

Add events by time/date and set Event Alarms to help manage your schedule.

 P.12-2, P.12-6

Music Player

Play 931P/microSD Card music files.

 P.8-1

Voice Recorder

Record your voice to set as ringtone, etc.

 P.12-10

microSD Mode

Access data on microSD Card from a PC by connecting handset to PC via USB cable (not included).

 P.9-21

Bluetooth®

Connect wirelessly to a Bluetooth®-compatible speaker to enjoy TV in dynamic sound.

 P.10-6

Osaifu-Keitai®

Use handset as an electronic cash card, reward card or membership card.

 P.16-1

Contents

Contents	vi
Package Contents	viii
Using This Guide	viii
Safety Precautions.....	xii
Handling Precautions	xviii
Copyrights and Others.....	xxi
Specific Absorption Rate (SAR)	xxv

1. Getting Started

USIM Card.....	1-2
Parts & Functions.....	1-4
About Battery	1-12
Handset Power On/Off.....	1-16
Manner Mode	1-17
Handset Menus.....	1-18
Standby Options & Event Indicators ...	1-21
Customizing User Interface	1-24
Private Menu	1-25
Simple Menu.....	1-26
Passwords.....	1-28
Multi Task	1-29
View Blind	1-30
My Number.....	1-30

2. Call

Making/Answering Voice Calls	2-2
Making/Answering Video Calls.....	2-6
International Calls.....	2-9
Expanded Call Functions	2-12

Call Log.....	2-13
Answer Phone.....	2-15
Optional Services	2-17

3. Text Entry

Text Entry.....	3-2
Entering Text.....	3-3
Conversion Methods (Japanese).....	3-6
Editing Text.....	3-9
User's Dictionary	3-10
Download Dictionary.....	3-10

4. Phone Book

Overview	4-2
Saving to Phone Book	4-3
Searching/Using Phone Book.....	4-6
Managing Phone Book	4-9
S! Addressbook Back-up.....	4-10
Account Details	4-13
Voice Dial.....	4-14

5. Digital TV

Basics.....	5-2
Initial Setup	5-4
Watching TV.....	5-5
TV Links (Japanese)	5-11
Recording/Playing Programs	5-12

6. Camera

Before Using Camera.....	6-2
Pictures/Videos.....	6-6

Focus Functions (Outside Camera) ...	6-13
Viewing Saved Images	6-14

7. Entertainment

Mobile Widget (Japanese)	7-2
S! Quick News (Japanese)	7-4
S! Information Channel/Weather (Japanese).....	7-6
E-Books (Japanese).....	7-8

8. Music Player

Overview	8-2
Saving Music	8-2
Using Music Player	8-5

9. Managing Files

Data Folder	9-2
Opening Files.....	9-4
Using/Editing Still Images	9-12
Managing Folders/Files	9-14
microSD Card.....	9-16

10. Connectivity

Infrared.....	10-2
IC Transmission	10-4
Bluetooth®	10-6
SoftBank Utility Software (Japanese).....	10-11
USB (Japanese)	10-11
AV Output.....	10-13

11. Handset Security		15. S! Appli		Messaging	18-18
Changing Phone Password	11-2	Before Using S! Appli	15-2	Internet.....	18-19
Security Functions	11-2	Using S! Appli	15-3	S! Appli	18-21
Restricting Calls/Messages.....	11-8	16. Osaifu-Keitai®		Osaifu-Keitai®	18-21
Reset.....	11-12	Basics.....	16-2	S! GPS Navi Settings	18-22
12. Tools		Using Osaifu-Keitai®	16-4	Default Settings	18-23
Calendar	12-2	IC Card Lock Functions	16-5	Confirming Settings.....	18-24
Tasks	12-5	17. S! GPS Navi		19. Appendix	
Alarms	12-6	About S! GPS Navi.....	17-2	Function List	19-2
Calculator	12-8	Using S! GPS Navi.....	17-2	Troubleshooting.....	19-10
Notepad.....	12-8	18. Settings		Software Update	19-12
Dictionary (Japanese)	12-9	Sound & Vibration	18-2	Quick Open Menu	19-14
Sound Recorders.....	12-10	Display.....	18-3	Key Assignments	
Bar Code Reader.....	12-11	Manner Mode	18-7	(5-touch Mode).....	19-15
13. Messaging		Incoming Settings.....	18-7	(2-touch Mode).....	19-16
Basics.....	13-2	Date & Time	18-8	(NIKO-touch Mode).....	19-17
Sending S! Mail & SMS.....	13-4	Call Settings	18-9	Symbol List	19-18
Receiving & Viewing Messages	13-10	Notification Light	18-10	Character Code List	19-19
Organizing/Using Messages	13-15	Text Entry.....	18-10	Weather Indicator List	19-24
14. Internet		Phone Book	18-11	Memory List.....	19-25
Getting Started	14-2	Voice Dial.....	18-11	Specifications	19-26
Using Yahoo! Keitai	14-3	Video Call	18-12	Index.....	19-27
Using PC Site Browser	14-5	Horizontal Open Position	18-13	Warranty & Service.....	19-33
Basic Operations.....	14-6	Digital TV	18-14	Customer Service.....	19-34
Using Information	14-8	Mobile Widget (Japanese)	18-15		
Option Menu Items.....	14-13	S! Quick News (Japanese)	18-16		
		Bluetooth®	18-17		

Package Contents

□ Handset (931P)

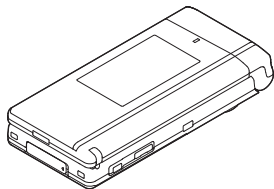

□ Battery (PMBAP1)

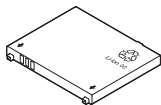

□ Starter Guide

Note

- Use SoftBank specified AC Charger (sold separately) to charge battery.
- For more information about AC Charger and accessories, please contact SoftBank Mobile Customer Center, General Information (☎P.19-34).
- Optional battery is available for separate purchase.
- 931P accepts microSD Card (not included). Purchase microSD Card to use related functions (☎P.9-16).

Using This Guide

Screenshots

Before reading this guide, make a note of the following:

- In this guide, SoftBank 931P User Guide, SoftBank 931P is abbreviated as 931P.
- "microSD Card" and "microSDHC Card" are referred to as "microSD Card" in this guide.
- Handset operations and screenshots are based on defaults for handset color **Pink** (☎P.18-23).
- Handset operations and screenshots are based on Normal Position.
- Sample screenshots, etc. are provided for reference only. Actual handset windows, menus, etc. may differ in appearance.
- Key icons use simplified labels.
- Most operation descriptions begin in Standby.
- Pressing a key for more than one second is described as "Press and hold."

Guide Symbols

Press the corresponding key to execute the function or operation indicated at the bottom of Display.

Example
(Normal Position):

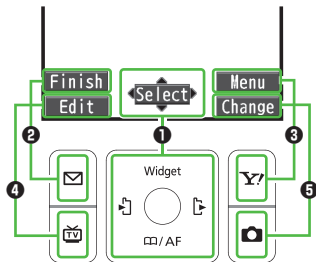

Example
(Horizontal Open Position):

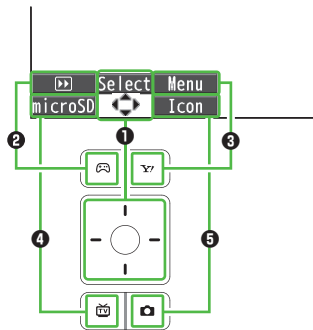

Multi Selector Operations (1)

Operations	Softkey Label*	
	Normal Position	Horizontal Open Position
Press to select an item		
Press	Select	

* Softkey labels vary by menu.

Multi Selector (1)

Use Multi Selector to select items, navigate menus, etc. In this guide, Multi Selector operations are indicated as shown below.

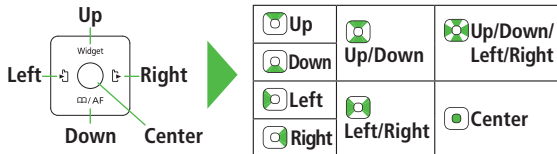

Softkeys (2 3 4 5)

In this guide, Softkey operations are indicated as shown below.

Example 2 3: [Finish], [Menu]

- [Finish] and [Menu] are Softkey label examples; Softkey labels vary by menu.
- 2 differs between Normal Position and Horizontal Open Position. This guide uses for operation descriptions.

Japanese Functions & Services

When "(Japanese)" appears in a title, Japanese ability is required to use full range of the function or service.

Operation Descriptions

- Following are examples of operation descriptions. Please note, actual operations may differ.

Basic Operations

Operations are expressed as shown here.

Example:

The diagram shows a sequence of menu selections: Main Menu → Phone Book → Group. Below this, it lists steps for editing a group. Step 1: Highlight a group, and press [Edit] → Select an item → Set item.

A Menu Selection

- 1 Press in Standby to open Main Menu.
- 2 Use to highlight **Phone Book**; then press [Select].
- 3 Use to highlight **Group**; then press [Select].

B Steps

- 1 Use to highlight a group; then press [Edit].
- 2 Use to highlight an item; then press [Select].
- 3 Set respective items.

Advanced Operations

For advanced features and settings, go to pages indicated under Tip.

Example:

The callout box contains a 'Tip' section with three items: 'Operations Available during a Voice Call (P.2-12)', 'Making Calls from Call Log (P.2-14)', and 'Saving Entered Numbers to Phone Book (P.4-5)'. Below it is a 'Settings' section with one item: 'Set Handset Response when Closed during Call (P.18-9)'. A line connects the 'Settings' section to a note below: 'Settings Refer to Chapter 18 "Settings."'.

Abbreviated Descriptions

For advanced settings (Chapter 18), initial operations may be abbreviated or omitted.

Example:

A Abbreviated Steps

Initial steps are abbreviated.

From ► Main Menu ► Tools ► Calendar

Functions Available in Calendar Window

> Highlight a date → [Menu] → Select an item (See below)

Item	Operation/Description
New	Create a new entry (P.12-2, P.12-3)
Weekly display/ 1 Month	Toggle Monthly/Weekly view
Icon display	Entries in category of selected icon appear > Select an icon

B Steps

Follow these steps after Abbreviated Steps.

Use Other Graphic Mail Settings



In S! Mail text entry window, → Select an arrange item

C Omitted Steps







Initial steps are omitted. Start operations from specified window.

Safety Precautions

- Before use, read these safety precautions carefully and use your handset properly. Keep this guide in a safe place for future reference.
- These safety precautions contain information intended to prevent bodily injury to the user and to surrounding people, as well as damage to property, and must be observed at all times.
- SoftBank is not liable for any damages resulting from use of this product.
- These symbols indicate exposure levels to bodily harm from failure to observe cautions or improper usage.
Make sure to understand these symbols and precautions before reading this guide.

	Danger	Great risk of death or serious injury from improper use
	Warning	Risk of death or serious injury from improper use
	Caution	Risk of injury or damage to property from improper use

- Symbol Explanations
Make sure to understand these symbols and precautions before reading this guide.

	Prohibited Action		Avoid Moisture
	Disassembly Prohibited		Always Dry Hands First
	Compulsory Action		Disconnect Power Source

Handset, Battery, USIM Card, Charger (sold separately) & microSD Card (not included)



Danger



Do not use or leave handset or related hardware in locations subject to high temperatures, such as near an open flame/ heater, in sunlight or inside a car on an extremely hot day. Do not charge, leave, use, or be carrying handset or related hardware in a warm place or where heat collects, such as under a kotatsu (blanketed warming table) or electric blanket, next to a kairo (worn warming patch), etc.
Battery may leak, overheat, explode, or ignite. Handset or related hardware may deform or malfunction. Part of the casing may also become hot and cause burns.



Do not use excessive force to attach battery or connect charger to handset. Battery or connector may be the wrong way around.
Battery may leak, overheat, explode or catch fire.



Do not disassemble, modify or solder handset.
May cause accidents such as fire, bodily injury, electric shock or equipment malfunction. Battery may leak, overheat, explode or catch fire. Modifying handset is a violation of Radio Law and subject to prosecution.



Do not get handset, battery and charger wet.
If handset, battery or charger is left wet or battery is charged after exposure to liquids such as water or pet urine, overheating, electric shock, fire, injury or malfunction may occur. Be mindful of location when using handset, battery and charger. Handle with care.



Use specified battery, charger (sold separately) and holder (not included).
Battery may leak, overheat, explode or catch fire, and charger may overheat, catch fire or cause malfunction.



Warning



Do not place handset, battery or charger inside cooking appliances, such as microwave ovens or high-pressure containers, or on IH cooking heaters.

Battery may leak, overheat, explode or catch fire, and handset and charger may overheat, emit smoke, catch fire or cause malfunction.



Do not drop, throw or otherwise subject to strong force or impacts.

Battery may leak, overheat, explode, catch fire, or cause electric shock or damage to handset.



Do not allow liquids (water, pet urine, etc.) or conductive objects (pencil leads, metal pieces, necklaces, hair pins, etc.) to contact charger terminals, external port terminals or microSD Card slot.

May cause fire or malfunction triggered by short-circuit.



Keep handset off and charger disconnected near propane gas, in filling stations or places where flammable gas is generated.

Handset use in such areas may lead to fire. Be sure to turn off handset before using Osaifu-Keitai®-compatible devices within filling stations (When IC Card Lock is set, turn off handset after unlocking setting.).



If handset, battery or charger emits an unusual sound, smoke or odor, perform following steps:

1. Unplug charger from outlet.
 2. Turn off handset.
 3. Remove battery (Take care to avoid burns or injuries.).
- May cause fire or electric shock.



Caution



Do not place handset, battery or charger on an unstable surface.

May fall, causing injury or malfunction. Take extra precautions while vibration alert is active or during charging.



Keep handset out of the reach of young children.

May result in accidental ingestion or bodily injury.



If for use by child, guardian should teach proper handling and ensure handset is used as directed.

May result in bodily injury.

Battery



Danger

See battery label to confirm battery type.

Label	Battery Type
Li-ion 00	Lithium-ion



Do not throw battery into fire.

Battery may leak, explode or catch fire.



Do not pierce battery with a nail or other sharp object, hit it with a hammer, step on it, or subject it to strong shocks.

Battery may leak, overheat, explode or catch fire.



Do not touch terminals with metallic objects or carry/store battery with conductive objects (pencil leads, metal pieces, necklaces, hair pins, etc.).

Battery may leak, overheat, explode or catch fire.



If battery fluid gets into eyes, do not rub; flush with clean water and see a doctor immediately. Failure to do so may cause blindness.



Warning



If battery fluid comes into contact with your skin or clothing, stop using handset immediately and rinse it off with clean water.

Battery fluid is harmful to your skin.



If battery does not charge after specified time, stop charging.

Battery may leak, overheat, explode or catch fire.



If battery emits an unusual odor, overheats, discolors or deforms, immediately remove battery and move it away as far as possible from any flame or fire. Take care to avoid burns or injuries.

Battery may leak, overheat, explode or catch fire.



Caution



Do not dispose of battery with ordinary refuse.

Place tape over the terminals to insulate battery, and take it to a SoftBank retailer or institution that handles used batteries in your area. Comply with local waste disposal regulations for recycling.

Handset



Warning



Do not use handset while driving a vehicle.

Doing so may interfere with safe driving and cause an accident. Stop your vehicle to park in a safe place before using handset. Drivers using handsets while driving are subject to prosecution.



Do not aim the infrared port at eyes when using infrared communication.

Doing so may affect eyes.



Do not point flash/photo light directly at someone's eyes. Do not look directly at flash/photo light while light is on.

May damage eyesight or cause accidents due to momentary sight loss or surprise. Do not take pictures of infants at close range.



Turn off handset near high-precision electronic devices or devices using weak electronic signals.

Handset may cause these devices to malfunction.

*Electronic devices that may be affected: Hearing aids, implantable cardiac pacemakers, implantable cardioverter defibrillators, other medical electronic devices, fire alarms, automatic doors and other automatically controlled devices.



Turn off handset aboard aircraft.

Handset signal may interfere with aircraft operation.

When in-flight handset use is permitted, follow airline instructions for proper use.



If you have a weak heart, take extra precautions when setting functions such as Vibration or Ringer Volume for incoming transmissions.

May affect heart.



In a thunderstorm, immediately turn off handset and seek shelter.

There is a risk of being struck by lightning and suffering electric shock.



Caution



If handset affects car electronics, stop use.

Handset use may affect electronics in some models. In this case, stop use; could impede safe driving.



Do not place a magnetic card near or in handset.

The stored magnetic data in cash cards, credit cards, telephone cards and floppy disks, etc. may be erased.



Do not swing handset by its strap, etc.

Handset may strike you or others, or strap may be broken resulting in injury or damage to handset or other property.



Do not place your ear too close to the speaker while ringer sounds or sound files play.

May impair hearing.



Do not use One-push Open button to open handset near your or another person's face.

Handset may cause accident and injury.



Do not use handset if catch (for Horizontal Open Position) remains protruding.

May cause injury.



Handset may become hot while used in a hot environment.

Avoid prolonged skin contact that may result in burns.



Avoid closing handset on fingers or objects when opening it.

May result in injury or damage to display.



Watch TV with adequate lighting and distance from Display.

May damage eyesight.



Do not turn up the volume unnecessarily high when using earphones.

Using earphones with volume turned up for an extended period may impair hearing or injure ears.



If skin abnormality occurs, immediately stop use and seek medical treatment.

Handset contains metals. Handset use may cause itching, rashes, eczema or other symptoms depending on the user's physical condition.

Parts		Materials/Surface Finish
Outer case	Internal Display side, External Display side, Battery side, Keypad side, Battery cover	ABS resin/ Acrylic UV cured coating
	External Display periphery	PC+ABS resin/ Acrylic UV cured coating
Side Keys, MULTI Key		ABS resin/ Acrylic UV cured coating
Ornamental parts of External Display		ABS resin/Evaporated tin, Acrylic UV cured coating
Internal Display panel, External Display panel, Outside Camera lens		Acrylic resin/Hard coating
Outside Camera panel		PET resin
Keypad		Acrylic urethane resin (Panel: PET resin)

Parts		Materials/Surface Finish
Shutter Key		PC resin/ Evaporated aluminum/ Acrylic UV cured coating
One-push Open Button		PC resin/ Acrylic UV cured coating
Metal part of One-push Open Button		Aluminium/Alumite treatment
External Port cover, microSD Card Slot cover		PC resin, Elastomer resin/ Acrylic UV cured coating
Hinge on Display side		PA resin/ Acrylic UV cured coating
Hook for Horizontal Open Position		Stainless steel/ Chrome plating on nickel plating
Charging Terminals		Phosphor bronze/ Gold plating on nickel plating
Stop pads, Screw caps on keypad side		Acrylic urethane resin
Horizontal Open Lever		Polyacetal resin
Charging Indicator/Notification Light, Infrared Port		Acrylic resin
Screws (Battery compartment)		Aluminium killed steel/ Nickel plating
Battery compartment		Glass fiber reinforced epoxy board (label: PET resin)
Battery compartment (Sides)		PC+ASA resin/Nickel plating on copper plating
Battery terminals	Resin part	PPS resin
	Metal part	Beryllium copper/ Gold plating on nickel plating

Parts		Materials/Surface Finish
Battery	Battery	PC resin (label: PET resin)
	Terminals	Glass fiber reinforced epoxy board/ Gold plating on nickel plating

Charger (sold separately)



Warning



Do not cover or wrap charger during charging.

May cause overheating, fire or malfunction.



Always use the specified power supply/voltage.

Using incorrect voltage may cause fire or malfunction.

AC Charger: AC 100V-240V (household AC outlet only)

In-Car Charger: DC 12V, 24V (vehicles with a negative earth only)



Use In-Car Charger in vehicles with a negative (-) earth.

Do not use In-Car Charger if vehicle has a positive (+) earth.

May cause fire.



Do not use charger in thunderstorms.

There is a risk of suffering electric shock.



Do not handle charger with wet hands.

May cause electric shock or malfunction.



If In-Car Charger fuse blows, always replace it with specified fuse.

Using the incorrect fuse may cause fire or malfunction. Refer to the respective manuals for information on the correct fuse specifications.



If dust accumulates on plug, unplug charger and wipe with a dry cloth.

May cause fire.



When plugging charger into outlet, keep conductive materials (pencil lead, metal parts, necklaces, hair pins, etc.) away from Desktop Holder terminals or charger plug/terminals and plug charger firmly into outlet.
May cause electric shock, short-circuit or fire.



Unplug AC Charger during periods of disuse.
May cause electric shock, fire or malfunction.



If liquid such as water or pet urine get into charger, unplug it immediately.
May cause electric shock, smoke emission or fire.



Caution



Pull charger (not cord) to unplug charger.
Pulling on the cord may damage the cord and cause electric shock or fire.



Always unplug charger before cleaning it.
May result in electric shock.

Near Electronic Medical Equipment



Warning

This section is based on "Guidelines on the Use of Radio Communications Equipment such as Cellular Telephones and Safeguards for Electronic Medical Equipment" (Electromagnetic Compatibility Conference, April 1997) and "Report of Investigation of the Effects of Radio Waves on Medical Equipment, etc." (Association of Radio Industries and Businesses, March 2001).



If you use an implantable cardiac pacemaker or cardioverter defibrillator, keep handset more than 22 cm away from the implant at all times.
Handset radio waves may affect implantable cardiac pacemaker or cardioverter defibrillator operations.



Persons using electronic medical equipment outside medical facilities should consult the vendor about possible radio wave effects.
Handset radio waves may affect electronic medical equipment operations.



Observe the following in medical facilities. Handset radio waves may affect electronic medical equipment.

- Do not take handset into operating rooms, Intensive Care Units or Coronary Care Units.
- Turn off handset inside hospital wards.
- Turn off handset even outside hospital wards (in hospital lobbies, etc.); electronic medical equipment may be in use nearby.
- Where a medical facility has specific instructions prohibiting the carrying and use of mobile phones, observe those instructions strictly.



Turn off handset in crowded places such as rush hour trains; implantable cardiac pacemakers or cardioverter defibrillators may be in use nearby.
Handset radio waves may affect implantable cardiac pacemaker or cardioverter defibrillator operations.

Handling Precautions

General Notes

- SoftBank is not liable for damages from accidental loss/alteration/repair of handset/microSD Card information (Phone Book entries, image/sound files, etc.). Back-up important information.
- Handset transmissions may be disrupted inside buildings, tunnels or underground, or when moving into/out of such places.
- Use handset without disturbing others.
- Handsets are radios as stipulated by the Radio Law. Under the Radio Law, handsets must be submitted for inspection upon request.
- Handset use near landlines, TVs or radios may cause interference.
- Read microSD Card manual beforehand for proper use.
- **Beware of eavesdropping.**
Digital signals reduce interception, however transmissions may be overheard. Deliberate/accidental interception of communications constitutes eavesdropping.
"eavesdropping" means radio communication is received by another receiver deliberately or accidentally.
- **Be cautious of unsafe websites. Take extra precautions especially when posting personal information on websites.**

Electromagnetic Waves

- For body worn operation, this mobile phone has been tested and meets RF exposure guidelines when used with an accessory containing no metal and positioning the handset a minimum 15 mm from the body. Use of other accessories may not ensure compliance with RF exposure guidelines.

FCC Notice

- **This device complies with part 15 of the FCC Rules. Operation is subject to the following two conditions:**
(1) This device may not cause harmful interference, and
(2) this device must accept any interference received, including interference that may cause undesired operation.
- **Changes or modifications not expressly approved by the manufacturer responsible for compliance could void the user's authority to operate the equipment.**

FCC RF Exposure Information

Your handset is a radio transmitter and receiver. It is designed and manufactured not to exceed the emission limits for exposure to radio frequency (RF) energy set by the Federal Communications Commission of the U.S. Government.

The guidelines are based on standards that were developed by independent scientific organization through periodic and thorough evaluation of scientific studies. The standards include a substantial safety margin designed to assure the safety of all persons, regardless of age and health. The exposure standard for wireless handsets employs a unit of measurement known as the Specific Absorption Rate, or SAR. The SAR limit set by the FCC is 1.6 W/kg. The tests are performed in positions and locations (e.g. at the ear and worn on the body) as required by the FCC for each model.

The highest SAR value for this model handset as reported to the FCC when tested for use at the ear is 0.788 W/kg, and when worn on the body in a holder or carry case, is 0.335 W/kg.

Body-worn Operation; This device was tested for typical body-worn operations with the back of the handset kept 1.5 cm from the body. To maintain compliance with FCC RF exposure requirements, use accessories that maintain a 1.5 cm separation distance between the user's body and the back of the handset. The use of beltclips, holsters and similar accessories should not contain metallic components in its assembly. The use of accessories that do not satisfy these requirements may not comply with FCC RF exposure requirements, and should be avoided. The FCC has granted an Equipment Authorization for this model handset with all reported SAR levels evaluated as in compliance with the FCC RF emission guidelines. SAR information on this model handset is on file with the FCC and can be found under the Display Grant section of <http://www.fcc.gov/oet/ea/> after searching on FCC ID UCE209017A. Additional information on Specific Absorption Rates (SAR) can be found on the Cellular Telecommunications & Internet Association (CTIA) website at <http://www.phonefacts.net>.

European RF Exposure Information

Your mobile device is a radio transmitter and receiver. It is designed not to exceed the limits for exposure to radio waves recommended by international guidelines. These guidelines were developed by the independent scientific organization ICNIRP and include safety margins designed to assure the protection of all persons, regardless of age and health.

The guidelines use a unit of measurement known as the Specific Absorption Rate, or SAR. The SAR limit for mobile devices is 2 W/kg and the highest SAR value for this device when tested at the ear was 0.820 W/kg*. As mobile devices offer a range of functions, they can be used in other positions, such as on the body as described in this user guide**. In this case, the highest tested SAR value is 0.397 W/kg. As SAR is measured utilizing the devices highest transmitting power the actual SAR of this device while operating is typically below that indicated above. This is due to automatic changes to the power level of the device to ensure it only uses the minimum level required to reach the network.

The World Health Organization has stated that present scientific information does not indicate the need for any special precautions for the use of mobile devices. They note that if you want to reduce your exposure then you can do so by limiting the length of calls or using a hands-free device to keep the mobile phone away from the head and body.

*The tests are carried out in accordance with international guidelines for testing.

** Please see Electromagnetic Waves on page xviii for important notes regarding body worn operation.

Declaration of Conformity

CE0168

We, Panasonic Mobile Communications Development of Europe Ltd., declare that SoftBank 931P conforms with the essential and other relevant requirements of the directive 1999/5/EC.

A declaration of conformity to this effect can be found at <http://panasonic.net/pmc/support/index.html>

- This product is only intended for sale in Japan.
- Compliance to the European RTTE directive applies to: SoftBank 931P handset, Battery (PMBAP1) and AC Charger (SoftBank ZTDA1).

Handset Care

- **931P is not waterproof. Avoid exposure to liquids and high humidity.**
 - Do not expose handset to precipitation.
 - Air conditioned air may cause condensation, resulting in corrosion.
 - Do not put handset in damp places like bathrooms.
 - On the beach, keep handset away from sun and surf.
 - Perspiration in handset may cause malfunction.
- **If handset is left with no battery or an exhausted one, data may be altered/lost. SoftBank is not liable for any resulting damages.**
- **Use handset within temperatures of 5°C to 35°C and humidity 35% to 85%. Avoid extreme temperatures/direct sunlight.**
- **Handset may become warm during use or charging. This is not malfunction.**
- **Exposing lens to direct sunlight may damage color filter and affect image color.**

- **Soiled terminals may cause poor connection. If the terminals are dirty, use a dry cloth or cotton swab to wipe them clean.**
- **Clean handset with dry, soft cloth. Using alcohol, thinner, etc. may damage it.**
- **Avoid forceful rubbing or scratching handset displays.**
- **Do not subject handset to excessive force.**
 - Do not sit down with handset in a back pocket.
 - Do not place heavy objects on a bag with handset inside.
- **Do not remove nameplate from handset; doing so invalidates warranty.**
- **Always turn off handset before removing battery. If battery is removed while saving or sending mail, data may be altered or lost.**
- **LCD is manufactured with high precision technology, however, some pixels may appear darker/brighter.**
- **Connect only specified products to External Port.**
- **While walking, moderate headphone volume to make sounds around you audible and help avoid accidents.**
- **When holding handset in use, do not cover Speaker.**

Function Usage Limits

These functions are disabled after handset replacement/upgrade or service cancellation: Camera; Digital TV; Music Player; S! Appli; Lifestyle-Appli.

After a period of disuse, these functions may become unusable.

Mobile Camera

- Be sure to observe proper etiquette when using the camera.
- Do not expose the camera lens to direct sunlight. Concentrated sunlight through the lens may cause the handset to malfunction.
- Be sure to try taking and previewing pictures before using the camera on important occasions like wedding ceremonies.
- Do not commercially use or transfer pictures taken with the camera without the permission of the copyright holder (photographer), except for personal use.
- Do not use the camera in locations where taking photos and recording videos are prohibited.

Copyrights and Others

Right of Portrait

Portrait right is the right of an individual to refuse to be photographed by others and protects from the unauthorized publication or use of an individual's photograph by others. Right of personality is a portrait right applicable to all citizens and right of publicity is a portrait right (property right) designed to protect celebrities' interests. Be careful when taking pictures with the handset camera. Photographing, publicizing and distributing photographs of citizens and celebrities without permission are illegal.

Copyrights

Sounds, images, computer programs, databases, other copyrighted materials, their respective works and copyright holders are protected by copyright laws. Duplicated materials are limited to private use only. If duplications (including conversion of data types), modifications, transfer of duplicates or distribution on networks are made without permission of copyright holders, this constitutes "Literary Piracy" and "Infringement of Copyright Holder Rights" and a criminal action for reparations and criminal punishment may be filed. If duplicates are made using handset, please observe the copyright laws. Materials captured with handset camera are also subject to the above.

This product is licensed under the MPEG-4 patent portfolio license, AVC patent portfolio license and VC-1 patent portfolio license for the personal and non-commercial use of a consumer to (i) encode video in compliance with the MPEG-4 Visual Standard, AVC Standard and VC-1 Standard ("MPEG-4/AVC/VC-1 Video") and/or

(ii) decode MPEG-4/AVC/VC-1 Video that was encoded by a consumer engaged in a personal and non-commercial activity and/or was obtained from a licensed video provider licensed to provide MPEG-4/AVC/VC-1 video.

No license is granted or implied for any other use.

Additional information may be obtained from MPEG LA, L.L.C. See <http://www.mpegla.com>.

MPEG Layer-3 audio coding technology licensed from Fraunhofer IIS and Thomson.

This product is protected by certain intellectual property rights of Microsoft Corporation and third parties. Use or distribution of such technology outside of this products is prohibited without a license from Microsoft or an authorized Microsoft subsidiary and third parties.

Windows Media®, Microsoft®, Windows® and Windows Vista® are trademarks or registered trademarks of Microsoft Corporation in the United States and other countries.

The abbreviations used for respective operating systems (Japanese version) in this guide are as shown below:

Windows Vista® is the abbreviation of Windows Vista® (Home Basic, Home Premium, Business, Enterprise, and Ultimate).

Windows® XP is the abbreviation of Microsoft® Windows® XP Professional operating system or Microsoft® Windows® XP Home Edition operating system.

Microsoft Windows operating system is abbreviated as "Windows" in this guide.

Java and all Java-based trademarks and logos are trademarks or registered trademarks of Sun Microsystems, Inc. in the U.S. and other countries.



Aplix, microJBlend and JBlend, and all Aplix-or JBlend-related trademarks and logos are trademarks or registered trademarks of Aplix Corporation in the U.S., Japan and other countries.

OKAO Vision is used for multiple face detection to improve camera AF. OKAO is a registered trademark or trademark of OMRON Corporation in JAPAN and other countries.

BookSurfing® is a registered trademark of CELSYS Inc., Voyager Japan, Inc. and INFOCITY Inc.

QR Code is a registered trademark of DENSO WAVE INCORPORATED.



microSDHC Logo is a trademark.

Chaku-Uta® and Chaku-Uta Full® are registered trademarks of Sony Music Entertainment (Japan) Inc.

This product is protected by certain intellectual property rights of Microsoft Corporation. Use or distribution of such technology outside of this product is prohibited without a license from Microsoft or an authorized Microsoft subsidiary. Content providers are using the digital rights management technology for Windows Media contained in this device ("WM-DRM") to protect the integrity of their content ("Secure Content") so that their intellectual property, including copyright, in such content is not misappropriated. This device uses WM-DRM Software to play Secure Content ("WM-DRM Software"). If the security of the WM-DRM Software in this device has been compromised, owners of Secure Content ("Secure Content Owners") may request that Microsoft revoke the WM-DRM Software's right to acquire new licenses to copy, display and/or play Secure Content. Revocation does not alter the WM-DRM Software's ability to play unprotected content. A list of Revoked WM-DRM Software is sent to your device whenever you download a license for Secure Content from the Internet or from a PC. Microsoft may, in conjunction with such license, also download revocation lists onto your device on behalf of Secure Content Owners.

This product contains software licensed complying with GNU General Public License (GPL), GNU Lesser General Public License (LGPL), etc. For more details, see the bundled "GPL/LGPL 等適用ソフトウェアのライセンスについて" leaflet.



Bluetooth

Bluetooth® is a registered trademark of the Bluetooth SIG, Inc.

The Bluetooth word mark and logos are owned by the Bluetooth SIG, Inc. and any use of such marks by Panasonic Mobile Communications Co., Ltd. is under license. Other trademarks and trade names are those of their respective owners.

This product is loaded with Bluetooth™ Stack for Embedded Systems Spec 2.0 by Toshiba Corp.

Powered by MascotCapsule®
MascotCapsule® is a registered trademark of HI CORPORATION
© 2009 HI CORPORATION. All Rights Reserved.

The image stabilization technology utilized is PhotoSolid, a product of Morpho, Inc. PhotoSolid is the registered trademark of Morpho, Inc. in Japan and other countries.

FeliCa is a contactless IC card technology developed by Sony Corporation.

FeliCa is a registered trademark of Sony Corporation.

 is a registered trademark of FeliCa Networks, Inc.

"Osaifu-Keitai" is a registered trademark of NTT DoCoMo, Inc. in Japan.

NetFront
Mobile Client Suite

ACCESSTM

This product contains NetFront Mobile Client Suite of ACCESS CO., LTD. ACCESS and NetFront are trademarks or registered trademarks of ACCESS CO., LTD. in the United States, Japan and other countries. ©2008 ACCESS CO., LTD. All rights reserved.

This software is based in part on the work of the Independent JPEG Group.

This product contains Browser module under licence from ACCESS CO., LTD. and NTT DoCoMo, Inc.

IrFront is a trademark or registered trademark of ACCESS CO., LTD. in Japan and other countries.

The IrDA Feature Trademark is owned by the Infrared Data Association and used under license therefrom.



This product contains Adobe® Flash® Lite™ Player under license from Adobe Systems Incorporated.
Copyright© 1996-2008 Adobe Macromedia Software LLC. All rights reserved.
Adobe, Flash and Flash Lite are either registered trademarks or trademarks of Adobe Systems Incorporated in the United States and/or other countries.

"SOFTBANK," SOFTBANK's equivalent in Japanese, and the SOFTBANK logo are trademarks or registered trademarks of SOFTBANK CORP. in Japan and in other countries.

S! Mail, Navi Appli, S! Appli, MOBILE WIDGET, Graphic Mail are trademarks or registered trademarks of SOFTBANK MOBILE Corp.

Yahoo! and the "Yahoo!" or "Y!" logos are trademarks and/or registered trademarks of Yahoo! Inc. in the US.

This product is manufactured or sold under license from InterDigital Technology Corporation.

The frequency band used for the Bluetooth® function of 931P is shared with other industrial, scientific or medical equipment (microwave ovens, etc.), and used at premises radio stations, amateur radio station, etc. (hereinafter "other radio stations").

- 1 Before using the Bluetooth® function, visually check that there are no other radio stations sharing the same frequency band nearby.
- 2 Should interference occur between 931P and other radio stations, move to another place or stop the Bluetooth® function (stop the transmission) immediately.
- 3 For additional information and support, contact us at the following number.

SoftBank Mobile Customer Center;

From a SoftBank handset, call toll free at 157 for General Information.

From landlines, see ☎P.19-34 "Customer Service".



This radio equipment operates in the 2.4 GHz band using the FH-SS modulation, and its maximum communication distance is 10m.

Other company and product names mentioned herein are trademarks or registered trademarks of their respective owners.

The software contained in 931P is copyrighted material; copyright, moral right and other related rights are protected by copyright laws. Do not copy, modify, alter, disassemble, decompile or reverse-engineer the software, and do not separate it from hardware in whole or part.

"One-push Open™" is a trademark of Panasonic Corporation.

Specific Absorption Rate (SAR)

931P meets the government's requirements for exposure to radio waves.

These requirements are based on scientific basis to assure that radio waves emitted from mobile phones and other handheld wireless devices do not affect human health. They require that the Specific Absorption Rate (SAR), which is the unit of measurement for the amount of radiofrequency absorbed by the head, shall not exceed 2 W/kg*. This limit includes a substantial safety margin designed to assure the safety of all persons, regardless of age or health, and meets the international standard set by International Commission on Non-Ionizing Radiation Protection (ICNIRP) in cooperation with World Health Organization (WHO).

All mobile phones, prior to product launch, must be certified as compliant with government requirements as stipulated by the Radio Law.

931P has been granted Technical Regulations Conformity Certification by TELECOM ENGINEERING CENTER. Its highest SAR value is 0.920 W/kg. This value was obtained by TELECOM ENGINEERING CENTER as part of the certification process. SAR tests were conducted with handset transmitting at its highest certified power level in accordance with testing methods set by the government. While there may be differences between the SAR levels for various handsets, they all meet the governmental requirements for safe exposure. The actual SAR level of the handset while operating can be well below the highest value. This is because the handset is designed to operate at multiple power levels so as to use only the power required to reach the Network. Additional information on SAR can be obtained on the following Websites:

Ministry of Internal Affairs and Communications

<http://www.tele.soumu.go.jp/e/sys/ele/index.htm>

Association of Radio Industries and Businesses (ARIB)

<http://www.arib-emf.org/index02.html> (Japanese only)

* Requirements are stipulated in Radio Law (Ordinance Regulating Radio Equipment, Article 14-2).

