

Declaration of Conformity

Hereby, Sharp Telecommunications of Europe Limited, declares that this 903SH is in compliance with the essential requirements and other relevant provisions of Directive 1999/5/EC.

A copy of the original declaration of conformity can be found at the following

Internet address:

<http://www.sharp-mobile.com>

Introduction

Congratulations on your new 3G/UMTS 903SH phone.

About This User Guide

This user guide is carefully designed to help you learn about your phone's features and operations quickly and effectively.

NOTICE

- We strongly recommend that you keep separate permanent written records of all important data. Data may be lost or altered in virtually any electronic memory product under certain circumstances. Therefore, we assume no responsibility for data lost or otherwise rendered unusable, whether as a result of improper use, repairs, defects, battery replacement, use after the specified battery life has expired or any other cause.
- We assume no responsibility, directly or indirectly, for financial losses or claims from third parties resulting from the use of this product and any of its functions, such as stolen credit card numbers, the loss or alteration of stored data, etc.
- All company and/or product names are trademarks and/or registered trademarks of their respective holders.
- Screen layout may differ from that illustrated in this user guide. The information described in this user guide is subject to change without notice.
- All the functions described in this user guide may not be supported by all networks.
- We assume no responsibility for downloaded contents, information, etc. from the network.

- Occasionally, a few black or bright pixels may appear on the screen. Please note that this will not have any impact on any of the features or on performance.

Copyright

According to copyright laws, the reproduction, alteration and use of material which is protected by copyright (music, pictures, etc.) is only permitted for personal or private use. If the user is not in possession of more extensive copyright or has not received the explicit permission from the copyright owner to reproduce, alter or use a copy which has been made or modified in this way, this is considered to be a violation of the copyright laws and gives the copyright owner the right to claim for damages. For this reason, avoid the illegal use of material which is protected by copyright.

Windows is a registered trademark of Microsoft Corporation in the United States and/or other countries.

Powered by JBlend™ Copyright 1997-2005 Aplix Corporation. All rights reserved.

JBlend and all JBlend-based trademarks and logos are trademarks or registered trademarks of Aplix Corporation in Japan and other countries.



Powered by Mascot Capsule®/Micro3D Edition™

Mascot Capsule® is a registered trademark of HI Corporation ©2002-2005 HI Corporation. All Rights Reserved.

Licensed by Inter Digital Technology Corporation under one or more of the following United States Patents and/or their domestic or foreign counterparts and other patents pending, including U.S. Patents: 4,675,863; 4,779,262; 4,785,450; 4,811,420; 5,228,056; 5,420,896; 5,799,010; 5,166,951; 5,179,571 & 5,345,467

T9 Text Input is licensed under one or more of the following: U.S. Pat. Nos. 5,818,437, 5,953,541, 5,187,480, 5,945,928, and 6,011,554; Australian Pat. No. 727539; Canadian Pat. No. 1,331,057; United Kingdom Pat. No. 2238414B; Hong Kong Standard Pat. No. HK0940329; Republic of Singapore Pat. No. 51383; Euro. Pat. No. 0 842 463 (96927260.8) DE/DK, FI, FR, IT, NL,PT.ES,SE,GB; Republic of Korea Pat. Nos. KR201211B1 and KR226206B1; and additional patents are pending worldwide.



miniSD™ is a trade mark of SD Card Association.



is a registered trademark of RealNetworks, Inc.

Bluetooth is a trademark of the Bluetooth SIG, Inc.



The Bluetooth word mark and logos are owned by the Bluetooth SIG, Inc. and any use of such marks by Sharp is under license. Other trademarks and trade names are those of their respective owners.

Contains Macromedia® Flash™ technology by Macromedia, Inc. Copyright © 1995-2005 Macromedia, Inc. All rights reserved.

Macromedia, Flash, Macromedia Flash, and Macromedia Flash Lite are trademarks or registered trademarks of Macromedia, Inc. in the United States and other countries.



Licensed by QUALCOMM Incorporated under one or more of the following United States Patents and/or their counterparts in other nations :

4,901,307	5,490,165	5,056,109	5,504,773	5,101,501
5,506,865	5,109,390	5,511,073	5,228,054	5,535,239
5,267,261	5,544,196	5,267,262	5,568,483	5,337,338
5,600,754	5,414,796	5,657,420	5,416,797	5,659,569
5,710,784	5,778,338			



BROWSER BY



OPENWAVE

CP8 PATENT

This product is licensed under the MPEG-4 Visual Patent Portfolio License for the personal and non-commercial use of a consumer to (i) encode video in compliance with the MPEG-4 Video Standard ("MPEG-4 Video") and/or (ii) decode MPEG-4 Video that was encoded by a consumer engaged in a personal and non-commercial activity and/or was obtained from a licensed video provider. No license is granted or implied for any other use. Additional information may be obtained from MPEG LA. See <http://www.mpegla.com>.

This product is licensed under the MPEG-4 Systems Patent Portfolio License for encoding in compliance with the MPEG-4 Systems Standard, except that an additional license and payment of royalties are necessary for encoding in connection with (i) data stored or replicated in physical media which is paid for on a title by title basis and/or (ii) data which is paid for on a title by title basis and is transmitted to an end user for permanent storage and/or use. Such additional license may be obtained from MPEG LA, LLC. See <http://www.mpegla.com> for additional details.

MPEG Layer-3 audio coding technology licensed from Fraunhofer IIS and Thomson.

Useful Functions and Services

Your phone offers you the following features:

- Video calls. You can talk while viewing each other on respective screens.
- 3D and colour Java™ games and applications with a graphic accelerator. You can also download various games and applications from Vodafone via the mobile Internet.
- A built-in digital camera for taking pictures and video clips.
- A message function for reading and creating SMS messages.
- MMS (Multimedia Messaging Services) for personalising your phone in various ways.
- Email for sending up to 300 KB and receiving mail with attachments.
- A colour WAP browser for accessing information on the mobile Internet.
- Your own ringtones and ringvideos. You can use downloaded sound or video clip files as a ringtone or ring video clip.
- A music player that can play back MP3, AAC and AAC+ format sound files.
- Playback of the downloaded sound and video clip files.
- A voice recorder function for recording and playing back voice clips.
- A Bluetooth® wireless technology interface for establishing contact and transmitting data with certain devices. You can transmit pictures, sounds, and video clips to OBEX-enabled phones.
- An Infrared interface for data communication. You can transmit pictures, sounds and video clips to OBEX-enabled phones.
- A data synchronisation function for updating Contacts List entries on the Internet.
- A schedule alarm for creating and sending schedule entries with alarm settings.
- Video output. You can connect your phone to other devices, such as TVs or videos set to output, and display Java™ data, images, or video clips.
- With the built-in digital camera, you can read texts and barcodes, and create QR codes.
- A miniSD™ memory card slot that expands connectivity with a PC using the memory card.

Contents

Introduction	1	Entering Characters	29
Your Phone	7	Changing the Input Language	30
Getting Started	8	Changing the Input Mode	30
Inserting the SIM Card and the Battery	11	My Dictionary	30
Removing the SIM Card and the Battery	12	Using Templates	31
Charging the Battery	13	Using the Menu	32
Inserting the Memory Card	14	Main Menu	32
Removing the Memory Card	14	Shortcut Keys	33
Connecting the Stereo Handsfree	15	Contacts List	34
Turning Your Phone On and Off	15	Changing the Name Order	34
Keypad Lock	15	Changing the List Displayed	34
Display Indicators	16	Selecting the Storage Memory	34
Opening Your Phone	17	Sorting the Contacts List Entries	35
Navigating Functions	19	Add New Contact	35
Using in the Normal Position of the Display	19	Viewing My Contact Details	35
Voice Call/Video Call Functions	20	Copying Contacts List Entries between SIM Card and Handset	35
Making a Voice Call	20	Finding a Name	36
Speed Dialling	21	Dialling from the Contacts List	36
Redialling	21	Editing Contacts List Entries	36
Answering a Voice Call	21	Assigning a Ringtone or a Ring Video Clip to Each Entry	37
In Call Menu (Voice Call)	22	Deleting Contacts List Entries	37
Making a Video Call	25	Manage Category	37
Answering a Video Call	26	Contact Groups	38
In Call Menu (Video Call)	26		

Memory Status	39
Speed Dial List	39
Sending a Contacts List Entry	39
Receiving a Contacts List Entry	39
Sending a Voice Clip Message or Video Clip Message Using an Address from the Contacts List	40
Synchronising Contacts List Entries with those on the Internet	40
Camera	41
Taking Pictures	41
Recording Video Clips	42
Using the Options Menu in the Viewer Position of the Display	42
Common Functions in the Photo and Video Camera Modes	42
Functions in the Photo Camera Mode	45
Functions in the Video Camera Mode	47
Messaging	49
SMS	49
MMS	49
Email	49
Creating a New Message	50
Messaging Settings	56
Vodafone live!	60
Navigating a WAP Page	61
Music	63
Music Player	63

My Items	65
Pictures	65
Sounds & Ringtones	66
Videos	67
Other Documents	67
Common Option Menus	68
Games & Applications	71
Text Templates	71
Memory Status	71
Entertainment	72
Games & Applications	72
Settings	74
TV & Video	76
Organiser & Tools	80
Calendar	80
Alarms	83
Calculator	84
Voice Recorder	85
Scanner	86
E-Book	87
Stopwatch	88
Tasks	88
World Clock	90
Countdown Timer	90
Expenses Memo	90
Phone Help	91

SIM Application	92	Troubleshooting	120
Settings	93	Safety Precautions and Conditions of Use	122
Profiles	93	CONDITIONS OF USE	122
Setting the Display	97	ENVIRONMENT	125
Sound Settings	100	PRECAUTIONS CONCERNING VEHICLE USE	125
Date & Time	100	SAR	125
Language Setting	101	INFORMATION ON PROPER DISPOSAL	126
Call Settings	102	PRECAUTIONS FOR USE IN USA	127
Video Call Settings	106	Specifications and Optional Accessories	129
Security	107	Specifications	129
Master Reset	108	Optional Accessories	129
Call Log	109	Index	130
Call Timers	109	List of Menu Functions	132
Data Counter	109		
Call Costs	110		
Connectivity	111		
Bluetooth	111		
Infrared	113		
Network Settings	114		
Flight Mode	115		
Internet Settings	115		
Memory Card	116		
Connecting 903SH to Your PC	118		
System Requirements	118		
3G/GSM Modem	118		
Handset Manager	119		
Software Installation	119		
Note	119		









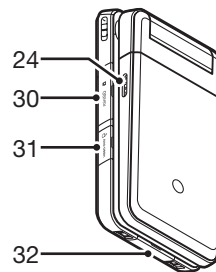
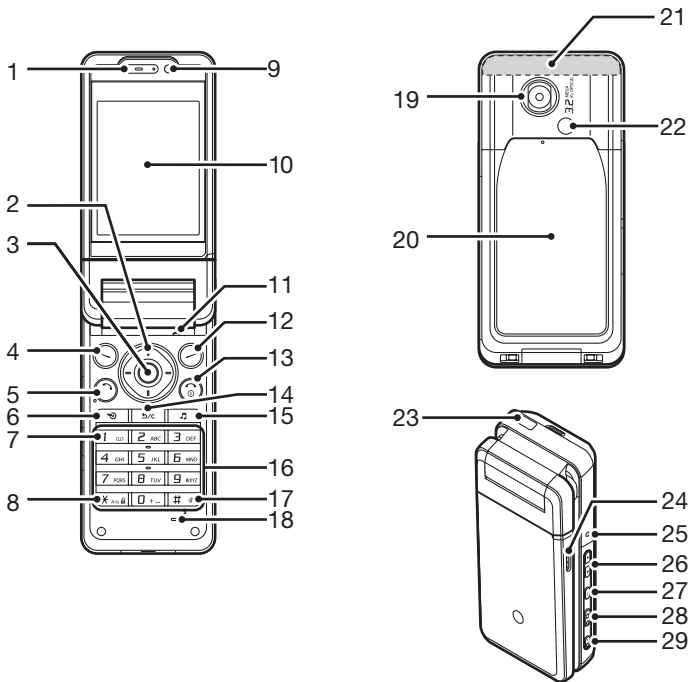

Your Phone









Please check the following carefully. Your phone should come complete with:

- 3G (UMTS)/GSM 900/1800/1900/GPRS phone
- Lithium-Ion Battery
- Battery Cover
- AC Charger
- Stereo Handsfree
- User Guide
- Quick Start Guide
- CD-ROM
- miniSD™ Memory Card
- Video Cable

Getting Started



1. **Earpiece**
2. **Navigation Keys (Arrow Keys):**
 -  Moves cursor to highlight a menu item, etc.
 - Up/Down arrow keys: Displays Contacts List entries in standby.
 - Left arrow key: Displays the message inbox in standby.
 - Right arrow key: Displays the monthly or weekly calendar in standby.
3. **Centre Key:**
 -  Displays Main menu in standby, and executes functions.
4. **Left Soft Key:**
 -  Executes the function in the lower left of the screen. Displays Messaging menu in standby.
5. **Send/Redial Key:**
 -  Makes or accepts calls, displays the call logs in standby.
6. **Shortcut Key:**
 -  Opens the shortcut menu to access the desired applications.
7. **Voicemail Key:**
 -  Press and hold to connect to the Voicemail centre (depending on the SIM card).
8. *** /Shift Key:**
 -  Switches character case between four modes: Abc, ABC, 123 and abc on the text entry screen. Press in standby to enter P, ?, – or *. Press and hold in standby to lock the keypad.
9. **Sub Camera (Internal Camera)**
10. **Main Display**
11. **Microphone (for the viewer position of the display)**
12. **Right Soft Key:**
 -  Executes the function in the lower right of the screen. Accesses “Vodafone live!” by opening the browser in standby.
13. **End/Power Key:**
 -  Ends a call and turns power on/off.
14. **Clear/Back Key:**
 -  Clears the characters to the left of the cursor, returns to the previous screen, etc.
15. **Music Key:**
 -  Displays Music menu in standby.
16. **Keypad**

17. **#/Silent Key:**
 Displays symbol screen on the text entry screen.
Press and hold to switch languages on the text entry screen.
Turns the flash/auxiliary light on or off in camera mode.
Press and hold in standby to switch Profiles settings between the mode most recently activated and Silent mode.
18. **Microphone**
19. **Camera (External Camera)**
20. **Battery Cover**
21. **Built-in Aerial:**
Warning: Do not cover the top of the phone with your hand when in use as this may interfere with the performance of the built-in aerial.
22. **Mobile Light:**
Used as a flash or an auxiliary light in camera mode.
23. **Infrared Port:**
Sends and receives data via infrared.
24. **Stereo Speakers**
25. **Small Light:**
Used for the battery charge indicator, Event Light and Status Light.
26. **Side Keys (/):**
(These two keys work in reverse with the viewer position of the display.)
Moves the highlight up or down.
Press in standby or during a call to increase or decrease the earpiece volume.
27. **Menu Key:**
 Executes the function in the lower left of the screen in the viewer position of the display.
28. **Camera Key:**
 Displays the Main menu when pressed in standby, then executes a highlighted function in the viewer position of the display.
Press and hold to activate the camera.
Press during an incoming call alert to answer the call in the viewer position of the display.
29. **Cancel Key:**
 Executes the function in the lower right of the screen in the viewer position of the display.
Press and hold in standby to turn the mobile light on. You can change the light colours by pressing  or  when the mobile light is on.
Press and hold to reject an incoming call.
Press during an incoming call alert to send a busy tone to the caller in the viewer position of the display.
Press to end the call in the viewer position of the display.

30. Memory Card Slot Cover

31. VIDEO OUT/Stereo Handsfree Connector

32. External Connector: Used to connect either the charger or a USB data cable.

Inserting the SIM Card and the Battery

1. Slide off the battery cover (① ②).

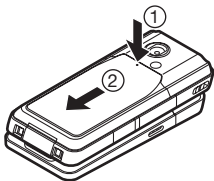

2. Slide the SIM card into the SIM holder.

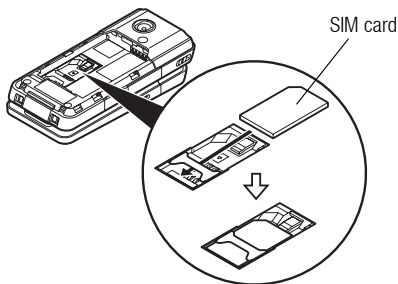

3. Hold the battery so that the metal contacts of the battery are facing down, slide the guides on the top of the battery into the battery slot (③), and then insert it (④).

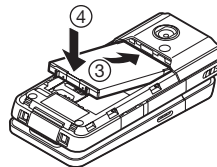

4. Replace the battery cover.

Note

- Make sure that only 3V SIM cards are used.
- Make sure that the standard accessory battery (XN-1BT70) is used.

Removing the SIM Card and the Battery

1. Ensure that the phone is turned off and that the charger and other accessories are disconnected. Slide off the battery cover.
2. Lift the battery using the protruding edge and remove the battery from the phone.
3. Hold ① down gently while sliding the SIM card out of the SIM holder (②).

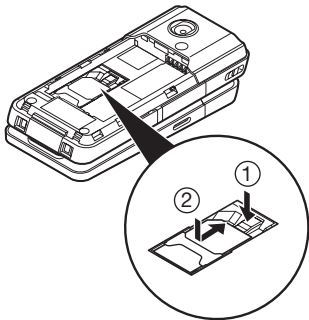

Battery Disposal

The device is battery-powered. In order to protect the environment, please read the following points concerning battery disposal:

- Take the used battery to your local waste depot, dealer or customer service centre for recycling.
- Do not expose the used battery to a naked flame, immerse in water or dispose with the household waste.

Charging the Battery

You must charge the battery for at least 140 minutes before using your phone for the first time.

Using the Charger

1. Open the cover of the external connector, connect the charger to the external socket located at the bottom of the phone by pressing both sides indicated with arrows, and connect to an AC outlet.

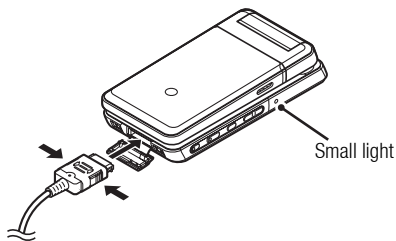

The small light turns on.

Standard charging time: Approx. 140 minutes

Note

- *Charging time may vary depending on the state of the battery and other conditions. (See "Battery" on page 122.)*

To Disconnect the Charger

When charging is complete, the small light turns off.

1. Unplug the charger from the AC outlet, then unplug the charger connector from the phone.
2. Close the cover.

Note

- *Do not use any non-approved chargers as they may damage your phone and invalidate any warranties, see "Battery" on page 122 for details.*

To Charge Using the Cigarette Lighter Charger

The optional cigarette lighter charger supplies power for charging from the cigarette lighter socket of a car.





Battery Level Indicator

The current battery level is displayed in the upper right of the main display.

Low Battery during Use

When the battery is running low, an alarm will sound and “” is displayed on the main display.

If you are using your phone and you hear the low battery alarm, attach your charger as soon as possible. The phone may not be able to continue normal operation if you continue to use it.

Battery Indicators	Charge Level
	Sufficiently charged
	Charging recommended
	Charging required
	Empty

Inserting the Memory Card

1. Turn off the phone.
2. Open the memory card slot cover and insert the card with the label side facing up.
3. Insert the memory card all the way in until it clicks.

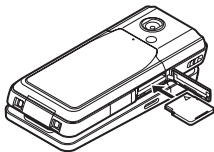





4. Close the cover.

Note

- Make sure that the phone is turned off before inserting the memory card.
- Be sure to insert the card in the correct direction and orientation.
- Do not open the memory card cover while the memory card is being formatted or written to. The card may be damaged beyond use.
- Keep all memory cards out of the reach of small children.

Tip

- You see the following indicators when the memory card is in use:
 -  : Appears when the card is inserted.
 -  : Appears when the card is damaged or unusable.
 -  : Appears when the card is being written or read.
 -  : Appears when the card is being formatted.

Removing the Memory Card

1. Open the memory card slot cover and slightly push the card so it pops out. Remove the card and close the cover.

Note

- Make sure that the phone is turned off before removing the memory card.
- Do not remove the memory card while the memory card is being formatted or written to.

Connecting the Stereo Handsfree

1. Open the cover of the Stereo Handsfree Connector.
2. Connect the Stereo Handsfree.

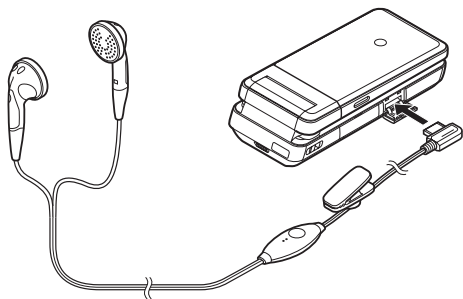

Turning Your Phone On and Off

To turn the power on or off, press and hold  for approximately 2 seconds.

To Enter the PIN Code

If activated you are asked to enter a PIN (Personal Identification Number) code and handset lock code after turning on your phone.

1. Enter your PIN code.
The PIN code is 4 to 8 digits.
2. Press .

Note

- If your PIN code is entered incorrectly three times in a row, the SIM card is locked. See “Enabling/Disabling the PIN Code” on page 107.
- If the clock settings have not been entered, the date and time entry screen is displayed (p. 100).

To Copy All Contacts List Entries from the SIM Card

When you insert the SIM card into your phone for the first time and start the Contacts List application, you are asked whether you wish to copy Contacts List entries on the SIM card. Follow the on-screen instructions, or you can do it later using the Contacts List menu as follows:



“Contacts” → **“Manage Contacts”** → **“Copy All Entries”**

1. Select “From SIM to Handset”.

Keypad Lock

You can lock the keypad to prevent it from being pressed accidentally.

Locking the Keypad

1. Press and hold  in standby.
To unlock, press and hold .

Tip





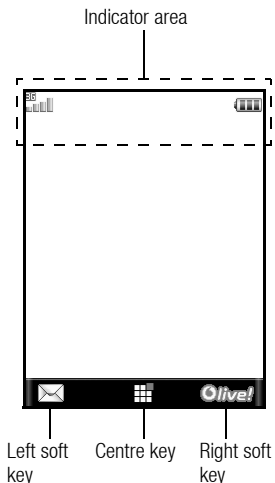









- Emergency numbers (112, etc.) can be entered and dialled regardless of the keypad lock.

Display Indicators



- / : Strength of received signal/Service out of range
 : 3G (UMTS)/GPRS
 : GSM/GPRS
 : Roaming outside network

- : Flight mode
- : Data exchange with external device
- : Connection to the server [established/communicating]
- : Voice call [incoming/in progress]
- : Video call communication mode enabled [voice and video/voice/video]
- : Alerts [text message and multimedia message/Email]
- : "Voice Calls" diverts set to "Always"
- : WAP/OTA provisioning alerts [WAP alert/OTA provisioning alert/WAP and OTA provisioning alerts]
- : Memory card inserted
- : Connection status [USB cable/Infrared exchanging information/Bluetooth wireless setting [enabled (in standby or except in standby)/exchanging information/talking with the Bluetooth headset]]
- : Java™ application [executed (colour)/suspended (grey)]

- 13. : Secure WAP page displayed
- 14. : Silent/vibration setting [silent/increasing volume/
vibration enabled/silent and vibration enabled/
increasing volume and vibration enabled]
- 15. : Speaker mode [speaker phone/speaker activated/
microphone muted]
- 16. (No display)/: Current profile [Normal/Meeting/Activity/Car/
Headset/Silent]
- 17. : Battery level
- 18. : Mobile light enabled
- 19. : Daily alarm enabled
- 20. : Schedule entry enabled [with/without reminder
alarm]
- 21. : Outbox contains unsent messages [text message/
multimedia/Email]
- 22. : Voicemail message alert
- 23. : Function Lock enabled
- 24. : Keypad Lock enabled
- 25. /(blank): Infrared setting [enabled/disabled]
- 26. : Secret mode set to "On"

Opening Your Phone

Your phone can be opened in the following three positions: normal, self-portrait and viewer positions.

Normal Position (1)

1. Open the phone until the display stops as illustrated.

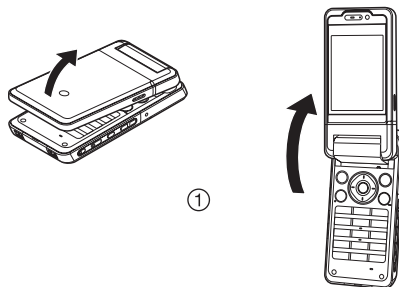

Self-portrait Position (②)

2. Turn the display 180° clockwise.

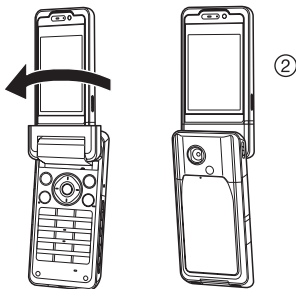



Use this position to take a self-portrait with the external camera. Do not turn the display anticlockwise as this may damage it.

Viewer Position (③)

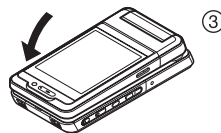
3. Close the main display toward the keypad.



Note

- Operations of  and  are reversed in the viewer position of the display.
- Keypad operations cannot be performed in the viewer position of the display.
- Be careful not to carry the phone in the viewer position of the display as this may damage the display.

Navigating Functions

Using in the Normal Position of the Display

All applications are accessed from the Main menu. To open the Main menu, press the centre key (●) in standby.

To launch applications, you will need to highlight menu items, and make selections. To select a menu item (indicated in quotation marks), move the cursor using ▲, ▼, ◀ and ▶, and press ● to select.

In certain procedures, you will need to press one of the soft keys (indicated in square brackets), which are displayed in the lower left and right of the screen. Press the corresponding soft key (☺ or ☹).

To return to the previous screen, press the right soft key if it displays *Back*. To close the Main menu, press the right soft key if it displays *Exit*.

Each section in this user guide starts with a list of items you will need to select in order (indicated in italics) before performing the procedures shown. Select each item to reveal the next set of items that you have to choose from. Open subsection items after opening those listed in the main section.

Example:

“Contacts” → ***“Contacts List”*** → ***“Add New Contact”***

Using in the Viewer Position of the Display

Available keys in viewer position of the display are ▲, ▼, ☺, ☹, ☺☹ and ☹☺.

To open the Main menu, press ☺☹ in standby.

To select a menu item (indicated in quotation marks), press ▲ or ▼, and press ☺☹ to select.

In certain procedures, you will need to press one of the soft keys (indicated in square brackets), which are displayed in the lower left and right of the screen. The left soft key is ☺ and the right soft key is ☹.

The side keys function in camera mode as follows:

▲/▼: Zoom-in/Zoom-out

☺: Options

☺☹: Capture

☹☺: Switches between the photo camera and video camera modes.

Voice Call/Video Call Functions

Making a Voice Call

1. Enter the area code and the phone number you wish to dial and press  to dial.

If you enter the wrong number, press  to delete the number to the left of the cursor.



Emergency Calls

1. Enter 112 (international emergency number) using the keypad and press  to dial.

Note

- *Emergency calls may not be able to be made on all mobile phone networks when certain network services and/or phone features are in use. Contact your service provider for more information.*
- *This emergency number can normally be used to make an emergency call in any country, with or without a SIM card inserted, if a 3G (UMTS)/GSM network is within range.*

International Calls

1. Press and hold  until a + (international dialling prefix) sign is displayed.
2. Enter the country code, followed by the area code (without the leading zero) and the phone number, and press  to dial.

Adding an Entered Phone Number to the Contacts List

1. After entering a phone number, press [Options] and select “Save Number”.

For details on creating a new entry, see “Add New Contact” on page 35.

Showing or Hiding My Phone Number on the Display of the Called Party

1. After entering a phone number, press [Options] and select “Show My ID” or “Hide My ID”.

Making a Call Using the Contacts List in the Viewer Position of the Display

1. Press .
2. Select “Contacts”.
3. Select “Contacts List”.
4. Select the entry you wish to call.
5. Select the phone number.
6. Select “Call” to dial.

To end a call, press .

Speed Dialling

Up to 8 phone numbers from the Contacts List memory (Handset and SIM) can be assigned to speed dials. You can call the numbers using the digit keys (**[1-9]** to **[9 menu]**). The phone number of the Voicemail centre is assigned to **[1-9]**.

For details on setting the speed dial list, see “Speed Dial List” on page 39.

1. To dial a number using the speed dial, press and hold any of the digit keys (**[1-9]** to **[9 menu]**).

The phone number saved in the speed dial list is dialled.

Redialling

You can redial numbers in the call log. Select from specific categories or “All Calls”. Specific categories contain up to 30 numbers and the “All Calls” list contains up to 90.

1. Press **[Call Log]** in standby.
2. Select the category from “All Calls”, “Dialled Numbers”, “Missed Calls” or “Received Calls”.

To switch logs, press **[Left Arrow]** or **[Right Arrow]**.

3. Highlight the phone number you wish to call.
4. Press **[Call]** to redial the call.

Answering a Voice Call

When an incoming call is detected, the phone rings.





1. Press **[Call]**, **[End Call]** or press [Options] and select “Answer” to answer the call.

Or press any key except **[Call]**, **[End Call]** and [Busy] when the “Any Key Answer” function is enabled. Set the Any Key Answer function in the profile of each mode (p. 97).

Tip

- If you have subscribed to the Calling Line Identification (CLI) service and the caller’s network sends the number, the caller’s number is displayed on the screen. If the caller’s name and number are saved in the Contacts List, the caller’s name and phone number are displayed on the screen.
- If the number is a restricted number, the display shows “Withheld”.
- When you receive a call from the person whose picture is registered in the Contacts List, the picture, name and phone number are displayed.

Answering a Call in the Viewer Position of the Display

1. Press  or  to answer the call.
To end a call, press .
To reject the incoming call, press and hold .

Rejecting an Incoming Call

1. Press  while the phone is ringing to reject a call you do not wish to answer.

Letting the Caller Know You are Unavailable







1. Press [Busy] while the phone is ringing to send a busy tone to the caller.

In Call Menu (Voice Call)





Your phone has additional functions available while a call is in progress.

Adjusting the Earpiece Volume

You can adjust the earpiece volume (and handsfree volume, if connected) from five levels.

1. Press  or  to display the Earpiece Volume screen.
2. Press  (or ) to increase the volume of the call or press  (or ) to decrease the volume.
3. Press  when the volume is set to the desired level.

Tip

- In the viewer position of the display, press  or  to display the in call menu.
- In the viewer position of the display, use  or  to increase or decrease the earpiece volume. Operations of these keys are reversed in the viewer position.

Turning the Speakers On and Off

You can talk via the loudspeakers on the sides of the phone when it is on.

1. During a call, press [Options] and select “Loudspeaker On”.

Putting a Call on Hold

This function allows you to manage two calls at the same time. If you wish to make another call while you are talking to someone, you can put the current call on hold to call someone else.

To Make Another Call during a Call

1. During a call, press [Options] and select “Hold”.
The current call is put on hold.
2. Press [Options] and select “Dial New Number”.
3. Enter the phone number you wish to make another call to, then press ☺.

Tip

- You can also make another call by entering the phone number during a call instead of step 1. The current call is automatically put on hold.

Accessing SMS/MMS Menu during a Call

1. During a call, press [Options] and select “Messaging”.
The following options are available: “Create Message” to make an SMS and MMS, or “Inbox”, “Sent” or “Drafts” to access these folders. For details on SMS, see “SMS” and “MMS” on page 49.

Call Waiting

This service notifies you of another incoming call while you have a call in progress.

1. During a call, press [Options] and select “Hold & Answer” to answer the second call.

The first call is put on hold and you can now talk to the second caller.

Note

- You need to set “Call Waiting” to “On” if you wish to use the Call Waiting service (p. 103).
- Call Waiting service may not be available on all networks. Contact your service provider for more information.
- If you do not wish to answer the second call, press [Options] and select “Busy” in step 1. If “Reject” is selected, the log of the second call is saved as a missed call.

Conference Call

Conference call is a call with more than 2 participants. You may include up to 5 participants in a conference call.

To Make a Conference Call

You must have one active call and one held call.

1. During a call, press [Options] and select “Multi Party”.
2. Select “Conference All” to join the conference call.
3. Press ☺ to end the conference call.

Note

- *The conference call service may not be available on all networks. Contact your service provider for more information.*
- *You have more options for the Conference call in step 2:*
 - *To put all participants on hold, select “Hold All”.*
 - *To put all participants except the current call on hold, select “Private”.*
 - *To end the call with all participants, select “End Active Call(s)” or “End Held Call(s)”.*
 - *To reject adding more participants to the current party, press [Options] and select “Reject”, or you can send the busy tone by selecting “Busy”.*

To Add New Participants to the Conference Call

1. Press [Options] and select “Dial New Number”.
2. Enter the number you wish to include in the conference call and press  to dial.
3. Press [Options] and select “Multi Party”.
4. Select “Conference All” to join the conference call.

If you wish to add other participants, repeat steps 1 to 4.

To End the Call with a Conference Call Participant

1. During a conference call, highlight the person that you wish to disconnect from the conference call.
2. Press [Options] and select “End This Call”.

To Have a Private Conversation with One of the Participants

If you wish to have a private conversation with one of the participants, you may select the participant from the conference list and put the other participants on hold.

1. During a conference call, select the person that you wish to talk to.
2. Press [Options] and select “Multi Party”.
3. Select “Private”.
4. Once you have finished the private conversation, press [Options] and select “Multi Party”.
5. Select “Conference All” to return to the conference call.

Muting the Microphone

1. During a call, press [Mute].
To use the microphone again, press [Unmute].

Making a Video Call

Note

- Use this function with only the video call enabled phones.
- Make sure that the battery is fully charged and the signal is strong before using this function.
- Turn the loudspeakers on or use a switch–equipped Stereo Handsfree or handsfree kit so that you can talk while looking at the video call screen on the main display.

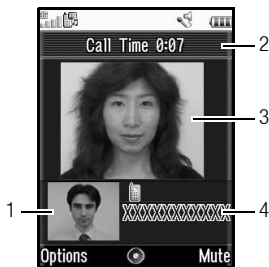

Status Indicators

1. Sub screen for your image
2. Elapsed time
3. Main screen for the calling party's screen
4. Calling party's name or phone number

Making a Video Call

1. Enter the area code and the phone number you wish to dial.
2. Press [Options] and select "Video Call" or press and hold  to dial.

If you enter the wrong number, press  to delete the number to the left of the cursor.

When the line is connected, the image of the called party is displayed upper on the screen, and yours lower left.

Tip

- If the called party's phone is not video call enabled, you can press  and enter the phone number again to make a voice call.
- When the call ends, the last call cost is displayed.

Answering a Video Call

When an incoming call is detected, the phone rings.

1. Press  to answer the call with video or press [Options] and select “Hide Picture” to answer with voice only.

Tip

- When the call ends, the call cost is displayed.
- If you have subscribed to the Calling Line Identification (CLI) service and the caller's network sends the number, the caller's number is displayed on the screen. If the caller's name and number are saved in the Contacts List, the caller's name is displayed on the screen.

Rejecting an Incoming Call

1. Press  while the phone is ringing to reject a call you do not wish to answer.

Letting the Caller Know You are Unavailable

1. Press [Busy] while the phone is ringing to send a busy tone to the caller of an incoming call letting them know that you cannot answer the call.

In Call Menu (Video Call)

Muting the Microphone

1. During a video call, press [Mute].
To use the microphone again, press [Unmute].

Swapping Images

You can swap images between the main and sub screens.

1. During a video call, press [Options] and select “Switch Images”.

Tip

- You can also swap images between the main and sub screens by pressing  during a video call.

Changing the Image of Yourself



1. During a video call, press [Options] and select “Camera Picture”.
2. Select “Internal Camera”, “External Camera” or “Alternative Image”.

“Internal Camera”: The image through the sub camera is displayed and sent to the caller.

“External Camera”: The image through the camera is displayed and sent to the caller.



“Alternative Image”: The camera is turned off and the image selected in “Alternative Image” of “Video Call Settings” is used.

Tip

- You can also switch the image shown to the caller by pressing  or  during a video call.

Using the Optical Zoom Function

The optical zoom enables you to zoom the picture more clearly by the actual zooming action of the optical lens. The optical zoom is used up to the [$\times 2$] zooming ratio. If the zoom exceeds [$\times 2$], the digital zoom is used to further magnify.

1. During a video call, press [Options] and select “Enable Opt. Zoom”.
2. Press  or .

Turning the Speakers On and Off

You can talk via the loudspeakers on the sides of the phone when it is on.

1. During a video call, press [Options] and select “Loudspeaker On”.

Note

- In a high-noise environment, you may not be able to continue a call, or make a clear call. We recommend that you use the Stereo Handsfree.
- With this option, there may be interruption if you increase the earpiece volume. We recommend that you decrease the earpiece volume or use the Stereo Handsfree.

Video Call Settings

To Adjust the Quality of the Incoming or Outgoing Image

You can adjust the quality of the called party's or caller's image.

1. During a video call, press [Options] and select “Video Call Settings”.
2. Select “Incoming Picture Quality” or “Outgoing Picture Quality”.
3. Select “Normal”, “Quality Priority” or “Frame Rate Priority”.



“Normal”:	The standard quality is used.
“Quality Priority”:	The quality of the picture takes precedence over the frame rate.
“Frame Rate Priority”:	The frame rate takes precedence over the quality.

To Turn the Backlight On or Off

You can turn on the backlight of your screen.

1. During a video call, press [Options] and select “Video Call Settings”.
2. Select “Backlight”.
3. Select “Always On”, “Always Off” or “As Normal Setting”.
When “Always On” is selected, the backlight will always be on during a video call.
When “As Normal Setting” is selected, the backlight will time out depending on the Backlight setting (p. 99).

To Adjust the Video Exposure

1. During a video call, press [Options] and select “Video Call Settings”.
2. Select “Exposure”.
3. Press  or .

Mirror Image

During a video call, you can reverse your image on the sub screen.

1. During a video call, press [Options] and select “Video Call Settings”.
2. Select “Mirror Image”.
3. Select “On” or “Off”.

To Change the Sub Camera Image to the Alternative Image

During a video call, you can switch the image shown to the caller between the sub camera image and an alternative image or display an image while putting a call on hold from the saved picture files.

1. During a video call, press [Options] and select “Video Call Settings”.
2. Select “Alternative Image” or “Hold Guidance Picture”.
3. Select “Preset Picture” or “My Pictures”.

Entering Characters

When entering characters to create Contacts List entries, text messages or multimedia messages, etc., press the corresponding keys.

In multi-tap input method, press each key until the desired character is displayed. For example, press **[2 ABC]** once for the letter A or twice for the letter B.

Table of Characters

Pressing each key scrolls characters in the following order. The order varies depending on the language selected.

English Mode

Key	Upper Case Characters	Lower Case Characters	Numeric
[1 QD]	. (full-stop) , (comma) - (hyphen) ? ! ' (apostrophe) @ :1		1
[2 ABC]	ABC2	abc2	2
[3 DEF]	DEF3	def3	3
[4 GHI]	GHI4	ghi4	4
[5 JKL]	JKL5	jkl5	5
[6 MNO]	MNO6	mno6	6
[7 PQRS]	PQRS7	pqrs7	7
[8 TUV]	TUV8	tuv8	8

Key	Upper Case Characters	Lower Case Characters	Numeric
[9 WXYZ]	WXYZ9	wxyz9	9
[0 +...]	(space) += < > € £ \$ ¥ % & 0		0
[X A/a B/b]	Switches character case between four modes: Abc, ABC, 123 and abc.		
[# #]	. , ? ! : ; - + # * @ ' " () _ & € £ \$ % / ~ < > § = \ ¥ ¡ ¢ £ ¤ ¥ ¦ § ¨ © ª « ¬ ® ¯ º » ¼ ½ ¾ à á â ã ä å ç è é ê ë ì ï ð ñ ò ó ô õ ö ø ù ú û ü ù Δ Φ Γ Λ Ω Π Ψ Σ Θ ☰ (space) ↵		

[1 QD] - **[9 WXYZ]** : Press and hold to enter numbers 1 - 9 and 0.

[0 +...]

[X A/a B/b] :

Press and hold to shift between multi-tap and T9 mode.

[# #] :

Press and hold to display the Input Language screen.







Changing the Input Language

1. On the text entry screen, press [Options] and select “Input Language”.
2. Select the desired language.

Changing the Input Mode

T9 Text Input

T9 text input method is a shortcut to enter text easily and quickly.

1. On the text entry screen, press and hold  to enter T9 mode.
2. Press [Options] and select “Input Mode”.
3. Select the input mode (Abc, ABC, 123, abc).
4. Press each key once for any letter you require on that key.
To enter the word “How”, press   .
5. If the word shown isn’t the one you want, press  or  until you highlight the correct one.
6. Press  to select the word.

Note

- If the correct word is not shown in step 5, enter the correct word again after switching to the multi-tap input method.

Tip

- If you press  instead of step 6, a space is inserted next to the selected word.

Symbols and Punctuation

1. On the text entry screen, press [Options] and select “Add Symbol”.
2. Select the desired symbol.

My Dictionary

You can create your own word list for T9 text input.

1. On the text entry screen in T9 mode, press [Options] and select “My Dictionary”.
2. Select “Add New Word” and enter a new word.

Editing a Word in the List

1. On the text entry screen in T9 mode, press [Options] and select “My Dictionary”.
2. Highlight the desired word.
3. Press [Options] and select “Edit”.
4. Modify the word.



Using Templates

You can use the phrases registered in Text Templates when entering characters.

For details on creating the text template, see “Adding Phrases to Text Templates” on page 71.

1. On the text entry screen, move the cursor to the point you wish to insert the template.
2. Press [Options] and select “Advanced”.
3. Select “Insert Template”.
4. Select the desired text template.







Copying, Cutting and Pasting Text

1. On the text entry screen, press [Options] and select “Advanced”.
2. Select “Copy” or “Cut”.
3. Move the cursor to the first letter to be copied or to be cut, then press .
4. Move the cursor to the last letter to highlight the area, then press .
5. Move the cursor to the point you wish to paste the letters.
6. Press [Options] and select “Advanced”.
7. Select “Paste”.





Using the Menu

Main Menu





1. Press  in standby.
The Main menu is displayed.
2. Press , ,  or  to highlight the desired menu, then press  to access the function.
For details on the menu options, see "List of Menu Functions" on page 132.

Using the Menu in the Viewer Position of the Display





1. Set the phone in the viewer position of the display.
2. Press  to display the Main menu.
3. Press  or  to move the cursor up or down, then press  or .

Press  to return to the Main menu.

The cursor moves the same as in the normal position of the display by using  and .



For details on the functions of these keys, see page 10.

Shortcut Keys

You can access menus by pressing  and digit keys for the corresponding number on the Main menu. For numbers 10 to 12, press  and  (10),  (11) or  (12). See “List of Menu Functions” on page 132.

Shortcuts are listed in the headings of this user guide.

Examples: To Access “Videos” Sub Menu (M 6–4) Using Shortcut Keys

Press   .

To Access “Totals” Sub Menu (M 7–11–2) Using Shortcut Keys

Press    .

To Access “Vibration” Sub Menu (M 12–3–4) Using Shortcut Keys

Press    .

Note

- The shortcut keys work for the first three menu levels only.

Contacts List (M 8–1)

You can store the phone numbers and Email addresses of your friends, family and colleagues in the Contacts List.

Your phone can store up to 500 entries. In a Contacts List, you can save the following items:

Items Saved in the Handset Memory

First Name	up to 16 characters
Last Name	up to 16 characters
Telephone Number	up to 3 phone numbers (up to 32 digits each)
Email Address	up to 3 Email addresses (up to 128 characters each)
Category	16 categories
Street & Number	up to 64 characters
City	up to 64 characters
State/Province	up to 64 characters
Postal Code	up to 20 characters
Country	up to 32 characters
Note	up to 256 characters
Birthday	(date)
Picture	(file name)
Assign Tone/Video	(file name)
Secret	(On or Off)

Items Saved in the SIM Memory (depending on the SIM card)

Name	up to 16 characters
Telephone Number	up to 2 phone numbers (up to 32 digits each)
Email Address	up to 128 characters (or no Email address)
Category	up to 16 categories

Changing the Name Order (M 8–8–1)

“Contacts” → **“Settings”** → **“Name Order”**

1. Select “First–Last Name” or “Last–First Name”.

Changing the List Displayed (M 8–8–2)

“Contacts” → **“Settings”** → **“Contacts Location”**

1. Select “Handset” or “SIM”.

Selecting the Storage Memory (M 8–8–3)

“Contacts” → **“Settings”** → **“Save New Contact to”**

1. Select “Handset”, “SIM” or “Choose before Saving”.

Tip

- “Choose before Saving” prompts you to choose the memory every time you save a new entry.

Sorting the Contacts List Entries (M 8–8–4)

You can change the order of the Contacts List entries to alphabetical order or order by category.

“Contacts” → **“Settings”** → **“Sort Contacts”**

1. Select “By Alphabet” or “By Category”.

Add New Contact

You can choose either the phone or SIM card memory locations to store the new entry. For switching locations, see “Selecting the Storage Memory” on page 34.

The amount of phone numbers that you can store to the SIM card is dependent on its capacity. Contact your service provider for details.

“Contacts” → **“Contacts List”** → **“Add New Contact”**

If you select the “Choose before Saving” option for the memory to be used, the selection is between “To Handset” and “To SIM”.

1. Select the field you wish to fill in, and enter the relevant information.
2. Press [Save] when finished.

Tip

- To create an entry, at least one field must be filled (“First Name”, “Last Name”, “Telephone Number” or “Email Address” for the handset memory; “Name”, “Telephone Number” or “Email Address” for the SIM memory).

Viewing My Contact Details (M 8–5)

You can register and edit your own contact as with other Contacts List entries.

“Contacts” → **“My Contact Details”**

Copying Contacts List Entries between SIM Card and Handset (M 8–9–1)

“Contacts” → **“Manage Contacts”** → **“Copy All Entries”**

1. Select “From SIM to Handset” or “From Handset to SIM”.

Note

- When you insert the SIM card into your phone for the first time and start the Contacts List application, the confirmation screen is displayed automatically, asking you if you wish to copy or not. The number of Contacts List entries to be copied varies depending on the SIM capacity.
- If the memory space is not enough to save all entries, you cannot complete copying.

Finding a Name

“Contacts” → “Contacts List”

1. Enter the first few letters of the name.
Search results are displayed in alphabetical order.

Tip



- You can select the Contacts location from “Handset” or “SIM” before searching.

Dialling from the Contacts List

“Contacts” → “Contacts List”

1. Highlight the desired entry and press .

Tip

- If more than one phone number is registered for the entry, highlight the desired phone number after step 1 and press .
- You can also dial from the details screen of the Contacts List. On the details screen, select the desired phone number and press .

Editing Contacts List Entries

“Contacts” → “Contacts List”

1. Highlight the entry you wish to edit.
2. Press [Options] and select “Edit”.
3. Modify the information.
4. Press [Save] when finished.

Adding a Thumbnail to Entries

“Contacts” → “Contacts List”

1. Highlight the desired entry.
2. Press [Options] and select “Edit”.
3. Select “Picture”.
4. Select “Assign Picture”.
5. Select the desired picture.
6. Press [Save] when finished.

Note

- If you delete a picture in the handset memory, the corresponding thumbnail is also deleted.

Assigning a Ringtone or a Ring Video Clip to Each Entry

“Contacts” → “Contacts List”

1. Highlight the desired entry.
2. Press [Options] and select “Edit”.
3. Select “Assign Tone/Video”.
4. Select “For Voice Call”, “For Video Call” or “For New Message”.
5. Select “Assign Tone” or “Assign Video”.
When selecting “Assign Video”, go to step 7.
6. Select “Preset Sounds” or “My Sounds”.
7. Select the desired tone or video clip.
8. Press [Save] when finished.

Deleting Contacts List Entries

Deleting All Contact Entries (M 8–9–3)

“Contacts” → “Manage Contacts” → “Delete All Entries”

1. Select “Handset Entries” or “SIM Entries”.
2. Enter your handset code.

The default handset code is “9999”. For details on changing the handset code, see “Changing the Handset Code” on page 108.

Deleting a Contact Entry

“Contacts” → “Contacts List”

1. Highlight the desired entry.
2. Press [Options] and select “Delete”.

Manage Category (M 8–3)

Different ringtones can be set for each category. If you do not change a category ringtone, the ringtone assigned in the Profiles menu is used.

“Contacts” → “Manage Category”

1. Highlight the desired category.
2. Press [Options] and select “Assign Tone/Video”.
3. Select “For Voice Call”, “For Video Call” or “For New Message”.
4. Select “Assign Tone” or “Assign Video”.
When selecting “Assign Video”, go to step 6.
5. Select “Preset Sounds” or “My Sounds”.
6. Select the desired tone or video clip.

For details on selecting a ringtone or a ring video clip, see “Assigning a Ringtone” or “Assigning a Ring Video Clip File” on page 94.

Note

- You can only edit category names in the SIM card. You cannot edit the ringtone or ring video settings.

Editing the Category Name

You can edit category names to be assigned to the Contacts List entries. First, change the Contacts List displayed (p. 34).

“Contacts” → “Management Category”

1. Highlight the desired category name.
2. Press [Options] and select “Edit Name”.
3. Modify the name.

Contact Groups (M 8–6)

You can create a mailing list to send the same message to a group of recipients at once. Up to 5 groups can be registered.

Creating a New Mailing List

“Contacts” → “Contact Groups” → “Add New Group”

1. Enter the group name.

The new group name is displayed following the last group on the Group List screen.

Adding Recipients to a Group

Up to 20 recipients can be registered in each list.

“Contacts” → “Contact Groups”

1. Select the desired group name.
2. Select “Assign New Entry”.
3. Select the desired entry.

The detailed screen is displayed.

4. Select the desired phone number or Email address.

Tip

- If you modify the entry assigned in the group, you need to re-assign it to the group. Press [Options] and select “Re-assign Entry” in step 2.
- To remove an entry from the group, press [Options] and select “Remove Entry” in step 2.
- To remove a group, highlight a group name and press [Options] and then select “Delete” in step 1.

Sending a Message Using a Mailing List

“Contacts” → “Contact Groups”

1. Highlight the desired group name.
2. Press [Options] and select “Create Message”.
3. Select the desired type of messaging.

For further procedures, see “Creating a New Message” on page 50.

Memory Status (M 8–9–2)

This function helps you to check the memory used in the Contacts List.

“Contacts” → **“Manage Contacts”** → **“Memory Status”**

Speed Dial List

You can set a maximum of 8 phone numbers in the Speed Dial list (p. 21).

Setting Contacts List Entries in the Speed Dial List

“Contacts” → **“Contacts List”**

1. Select the desired entry.
2. Highlight the desired phone number.
3. Press [Options] and select “Add to Speed Dial”.
4. Select the desired location.

Tip

- *The nine digit keys correspond to list numbers.*

To Edit the Speed Dial List (M 8–4)

“Contacts” → **“Speed Dial List”**

1. Highlight the entry you wish to edit.
2. Press [Options] and select “Re–Assign” (or “Assign”).

Sending a Contacts List Entry

“Contacts” → **“Contacts List”**

1. Highlight the desired entry.
2. Press [Options] and select “Send Contact”.
3. Select “As Message”, “Via Bluetooth” or “Via Infrared”.
For details on creating a message, see “Creating a New Message” on page 50.
For details on *Bluetooth* wireless settings, see “Bluetooth” on page 111.
For details on Infrared settings, see “Infrared” on page 113.

Receiving a Contacts List Entry

When the phone receives a Contacts List entry, a confirmation message is displayed in standby.

1. Press [Yes].

The received entry is saved in the Contacts List. Press [No] to reject.

Tip

- *For details on entering Infrared or Bluetooth wireless settings, see “Connectivity” on page 111.*

Sending a Voice Clip Message or Video Clip Message Using an Address from the Contacts List

“Contacts” → “Contacts List”

1. Select the desired entry including the phone number or Email address you wish to use.
2. Highlight the desired phone number or Email address.
3. Press [Options] and select “Create Message”.
4. Select “Voice Message” or “Video Message”.

For further procedures, see “Creating a New Message” on page 50.

Synchronising Contacts List Entries with those on the Internet (M 8–7)

The data synchronisation function is a network service and allows you to save your Contacts List entries in the handset memory on the Internet server. The data in the SIM card will not be saved. Subscribe to a synchronisation service by contacting your network service centre.

Synchronising the Contacts List (M 8–7–1)

“Contacts” → “Synchronise”

1. Select “Sync Now!” to synchronise data.

Note

- “Sync Now!” is not available if there is no active Synchronisation Setting.

Viewing the Log (M 8–7–2)

“Contacts” → “Synchronise”

1. Select “View Log”.

Synchronisation Settings (M 8–7–3)

“Contacts” → “Synchronise” → “Sync Settings”

1. Select the desired account or “Create New” to enter the following settings.

“Profile Name”:	Synchronisation profile name (Unique name)
“Server Name”:	Server address
“User ID”:	User ID for authentication
“Password”:	Password for authentication
“Proxy”:	Selects Proxy setting for synchronisation.
“Contacts DB Name”:	Contacts List database name on the server

Note

- Synchronisation settings have already been entered in your phone depending on your service provider. You may have restrictions on viewing, deleting, copying or modifying the settings. Contact your service provider for details.

Camera (M 5)

Your phone has a built-in digital camera that allows you to take pictures and record video clips wherever you are. This section starts with basic functions and operational procedures to take, save and send pictures and video clips, followed by common and unique functions to camera and video modes.

Taking Pictures

“Camera”

1. Press  to take the picture.

The shutter sounds and the still image of the taken picture is displayed.





2. Press [Save].

The taken picture is saved in My Items.

To cancel, press [Cancel].

To send the taken picture, press  in step 2 and select “As Message” or “As Postcard” from the send option. (The Postcard service is not available with some service providers. Contact your service provider for more information.)

Note

- Press  instead of  in the viewer position of the display.
- When the video camera is launched, press [Options] and select “Go to Photo Camera”, or press  or  (in the viewer position of the display) to go to the photo camera mode.
- When you try to send the picture that has too large a file size, the picture size is resized for the message. The original sized picture is saved in My Items.

Tip

- You can activate the camera by pressing and holding . Simply press  to take pictures, and start and stop recording.
- You can lock the focus by pressing  or pressing  halfway before taking a picture or recording a video clip.

Taking a Self–Portrait

You can take a self-portrait while looking at the main display.

“Camera”

1. Press [Options] and select “Switch to Int. Camera”.

Or press  in the viewfinder mode.

2. Press  to take the picture.

3. Press [Save].

The taken picture is saved in My Items.

To return to the external camera, press [Options] and select “Switch to Ext. Camera” or press  in the viewfinder mode.

To take a picture in the Self–Portrait position

You can take a self-portrait with the external camera.

1. Rotate the main display 180° clockwise from the normal position.
2. Press  on the side of the phone.

Note

- Do not rotate the main display anti–clockwise. Otherwise, the phone may malfunction.

Exiting from the Camera Mode in the Viewer Position of the Display

1. Press and hold  in the viewer position.

Recording Video Clips

You can record a video clip with your phone. You can also use this function in the viewer position of the display.

Recording Video Clips

“Camera”

The preview is displayed on the screen.

1. Press .

Press  in the viewer position of the display.

2. To stop recording, press .

3. Select “Save”.

The video clip is saved in My Items.

To view the preview before saving, select “Preview”.

To send the video clip, select “Save and Send”. Then select the desired way you wish to send. For further procedures, see “Creating a New Message” on page 50.



Note

- You can only send video clips when “For Message” is selected for the recording time. For details, see “Selecting the Recording Time and Size” on page 47.

Using the Options Menu in the Viewer Position of the Display

1. Press .



The Options menu is displayed graphically.

2. Press  or  to highlight the desired option and then press  to make the selection.

Common Functions in the Photo and Video Camera Modes

Using the Digital Zoom Function

To Adjust the Zooming Ratio

1. In the viewfinder mode, press  or .

To Enable the Optical Zoom

The optical zoom enables you to zoom the picture more clearly by the actual zooming action of the optical lens. The optical zoom is used up to the [×2] zooming ratio. If the zoom exceeds [×2], the digital zoom is used to further magnify.

“Camera” → [Options] → “Settings” → “Optical Zoom”

1. Select “Enable”.

Select “Disable” to disable.

If you select “Disable”, you can only use the digital zoom function.

2. Press or .

Once the phone has returned to standby, the zoom settings return to default.

Adjusting the Exposure

“Camera” → [Options] → “Exposure”

1. Press (Bright) or (Dark).

     : (Dark → Normal → Bright)

Once the phone has returned to standby, the brightness settings return to default.

Mobile Light

To Change the Mobile Light Mode

Set the mobile light according to your purpose.

“Camera” → [Options] → “Modes” → “Mobile Light” → “Switch On/Off”

1. Select the desired mode.

“On” (): The light is always on.

“Automatic” (): The light turns on if the phone detects that the conditions are dark.

“Low Light” () (photo camera mode only):

Select this mode for macro shooting.

“Off”: The light is always off.

The corresponding indicator is displayed on the screen. Select “Off” to turn it off.

To Change the Light Colour

You can take a picture in various colour modes.

“Camera” → [Options] → “Modes” → “Mobile Light” → “Light Colour”

1. Select the desired light colour.

Light Colours: White/Red/Yellow/Green/Blue/Violet/Light Blue



Using the Self-Timer

“Camera” → [Options] → “Modes” → “Self-timer”

1. Select “On” or “Off”.

 is displayed on the screen when you select “On”.

Switching between the Photo and Video Camera Modes

You can switch between the camera and video camera modes by pressing  or , or  (in the viewer position of the display).

Select the appropriate option.

“Camera” → **[Options]** → **“Go to Video Camera”**

“Camera” → **[Options]** → **“Go to Photo Camera”**

Selecting the Picture or Video Quality

Select the appropriate option.

“Camera” → **[Options]** → **“Picture Quality”**

“Camera” → **[Options]** → **“Video Quality”**

1. Select the desired picture or video quality.

: Super Fine

: Fine

: Normal

Note

- The better quality you select, the larger file size is needed.

Selecting the Storage Memory

Select the appropriate option.

“Camera” → **[Options]** → **“Settings”** → **“Save New Pictures”**

“Camera” → **[Options]** → **“Settings”** → **“Save New Videos”**

1. Select the desired location from “To Handset Memory”, “To Memory Card” or “Choose bef. Saving”.

Note

- If you select “Choose bef. Saving”, select the desired location every time you save.

Focus Setting

“Camera” → **[Options]** → **“Modes”** → **“Focus”**

1. Select the desired option.

AF: Auto Focus

MF: Manual Focus

: Macro

Auto Save

You can set the phone to save pictures and video clips automatically.

“Camera” → **[Options]** → **“Settings”** → **“Auto Save”**

1. Select “On” or “Off”.

Auto Start

You can set the phone to start the camera application automatically by switching to the viewer position of the display.

“Camera” → **[Options]** → **“Settings”** → **“Auto Start”**

1. Select “On” or “Off”.

Using the Help Function

“Camera” → **[Options]** → **“Help”**

Common Shortcut Keys

If multiple options exist, they switch each time you press each following key.

	Photo Camera	Video Camera
1 <small>Q</small>	Zoom Max/Min	
2 <small>ABC</small>	Exposure	
3 <small>DEF</small>	Focus	
4 <small>GHI</small>	Save New Pictures to	Save New Videos to
5 <small>JKL</small>	Picture Size	
6 <small>MNO</small>	Scene	Microphone On/Off
7 <small>PNQ</small>	Picture Quality	Video Quality
8 <small>TUV</small>	Self-timer On/Off	
9 <small>WXYZ</small>	Change Light Colour (when light is on)	
* / <small>AB</small>	Change External Camera/Internal Camera	
0 <small>+ -</small>	Switches Viewfinder	Switches Screen
# <small>OFF</small>	Light On/Off	

Note

- The “Switches Screen” option is available in “Preview” before you save a video clip. See “Recording Video Clips” on page 42.

Functions in the Photo Camera Mode

Selecting the Picture Size

You can select the size of pictures. All taken pictures are saved in the JPEG format.

“Camera” → [Options] → “Picture Size”

1. Select the desired size.

(External Camera)	1536 × 2048 dots/1200 × 1600 dots/ 960 × 1280 dots/768 × 1024 dots/ 480 × 640 dots/240 × 320 dots/ 120 × 160 dots
(Internal Camera)	240 × 320 dots/120 × 160 dots

Selecting the Scene

You can select the appropriate mode by scene when you take the picture.

“Camera” → **[Options]** → **“Modes”** → **“Scene”**

1. Select the desired scene.

The following eight modes are available:

“Automatic” (A): Automatically adjusted to surroundings.

“Night” (🌙): Suited for night photography.

“Sports” (🏃): Suited for moving objects.

“Characters” (👤): Suited for high-contrast subjects such as text.

“Pet” (🐾): Suited for moving objects at short range.

“Against Sun” (☀️): Suited to avoid objects being silhouetted against the light.

“Portrait” (👤): Suited for a portrait.

“Portrait in Dark” (👤): Suited for a portrait indoors or in dim light.

Selecting the Picture Effects

You can take a picture with special effects.

“Camera” → **[Options]** → **“Modes”** → **“Camera Effects”**

1. Select the desired effects.

The following five modes are available:

“Off”: The camera effect is cancelled.

“Sepia”: Creates a sepia-tone image.

“Monochrome”: Creates a black and white image.

“Negative”: Creates a negative image.

“Sketch”: Creates a sketch-like image with contours of objects outlined.

Note

- You cannot use the Camera Effects function for picture sizes larger than 480 × 640 dots.

Continuous Shoot

There are various modes for taking continuous shots.

“Camera” → **[Options]** → **“Modes”** → **“Continuous Shoot”**

1. Select the desired mode.

The following continuous shoot modes are available:

“Off”: The continuous shoots are cancelled.

“4 Pictures”/“9 Pictures” (📷/📷):

Takes 4 or 9 pictures continuously.

After selecting this mode, select from five types of speed or “Manual”.

“Overlapped” (📷): Overlaps continuous pictures into one picture and makes an afterimage.



After selecting this mode, select “Fast” or “Normal”.

“Bracket” (📷):

Takes 9 continuous pictures with various colours and brightness levels.

After selecting this mode, select “Fast” or “Normal”.

Note

- When you select “Manual” to take continuous pictures, press  or  (in the viewer position of the display) manually in the desired speed.
- When the Timer and Continuous Shoot functions are simultaneously set, “ ” (for “4 Pictures”, for example) is displayed instead.
- You cannot use the Continuous Shoot function for picture sizes larger than 768 × 1024 dots. “9 Pictures”, “Overlapped” and “Very Fast” for “4 Pictures” are not available for picture sizes larger than 480 × 640 dots.

Selecting a Frame

You can select the frame from preset patterns or My Pictures.

“Camera” → [Options] → “Modes” → “Add Frame”

1. Select “Preset Frames” or “My Pictures”.
2. Select the desired frame.
The selected frame is confirmed on the display.
3. Press .

Note

- Images larger than 240 [W] × 320 [H] dots cannot be used.

Using the Full Screen

You can display the preview on the full screen without the soft key area and indicator area.

“Camera” → [Options] → “Settings”

1. Select “Full Viewfinder”.
To return to the normal viewfinder, select “Normal Viewfinder”.

Selecting the Shutter Sound

“Camera” → [Options] → “Settings” → “Shutter Sound”

1. Select the desired shutter sound from 3 preset patterns.

Note

- Continuous Shoot uses the specialised shutter sound that cannot be changed from the above settings.
- The shutter sound remains active even when “General Volume” (p. 93) is set to “Silent” to prevent unauthorised use.

Functions in the Video Camera Mode

Selecting the Recording Time and Size

“Camera” → [Options] → “Record Time/Size”

1. Select “For Message” or “Extended Video”.
“For Message”: Limits the size to send a message depending on service providers.
“Extended Video”: Less than 30 minutes (depending on the memory)
2. Select “Large(QCIF)” or “Small(SubQCIF)” picture size for “For Message” and “QVGA(3gp)”, “QVGA(asf)”, “Large(QCIF)” or “Small(SubQCIF)” picture size for “Extended Video”.

Note

- If you select “For Message” for the recording time, the file size is limited depending on the service provider.
- “Save and Send” is not displayed after recording in the Extended Video mode.

Recording Video Clips with the Sound

To record a video clip with the sound, the microphone needs to be activated.

“Camera” → **[Options]** → **“Settings”** → **“Microphone”**

1. Select “On” or “Off”.

Note

- The microphone is already turned on in the default setting. Select “Off” to record a video clip without the sound.
- The file size of a video clip can be reduced if the sound is not recorded.

Video Encoding

“Camera” → **[Options]** → **“Settings”** → **“Video Encode”**

1. Select the appropriate format.

Messaging (M 4)

Your phone allows you to send and receive text, multimedia and Email.

SMS

SMS allows you to send text messages up to 765 characters long. If you send a message of more than 160 characters, it is split into several segments.

MMS

MMS allows you to send and receive multimedia messages of up to 300 KB with images, sound, or video clips attached.

Email

Email allows you to send messages of up to 300 KB.

Note

- Some MMS functions may not always be available depending on your network. Contact your service provider for more information.
- Maximum message size varies depending on the settings by the service provider.

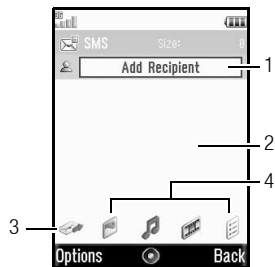

1. Recipient field
2. Message field
3. Send indicator
4. Attachment indicators (from left: picture, sound, video clip, others)

Creating a New Message (M 4–1)

(SMS/MMS)

⊖ → “Create Message” → “Message”

(Email)

⊖ → “Create Message” → “Email”

1. Select the address field.
2. Select the desired method to enter the address.
3. For MMS, enter or select the Email address or phone number from the Contacts List. For SMS, enter or select a phone number. For Email, enter or select an Email address.
 - To add multiple Email addresses or phone numbers, highlight the recipient field, press [Options], select “Edit Recipients”, then select “Add Contact”. Enter or select the Email address or phone number from the existing Contacts List.
 - To change the recipient types, press [Options], select “Edit Recipients” and highlight the desired recipient. Press [Options] and select “Change to To”, “Change to Cc” or “Change to Bcc”.
 - To add a subject, press [Options] and select “Add Subject”.
4. Place the cursor in the message field.
5. Enter the message.
6. Highlight the “Send” indicator in the lower left of the screen. Press  and select “Send Message”.
After the message is sent, the message is moved to the Sent box.

Tip

- To send the same message to a group of recipients, select “Select Group” in step 3, then select the desired group name. For details on creating a mailing list, see “Creating a New Mailing List” on page 38.

To Add a Slide Show

1. In step 5 in “Creating a New Message”, press [Options] and select “Add Slide”.
If you wish to add more slides, select “Add Slide After” or “Add Slide Before”.
2. Enter the message.
If you wish to set the duration of each slide, highlight the space between the slides. Press [Options] and select “Slide Duration”, then select the desired duration.

Tip

- You can create messages up to 300 KB. Each slide can contain one picture and/or one sound file or video clip.

To Attach My Items Data

1. In step 5 in “Creating a New Message” on page 50, highlight the “Picture”, “Sound” or “Video” indicator in the lower centre of the screen, and then press .
2. Select “Saved Pictures”, “Saved Sounds” or “Saved Videos”.
3. Select the desired file.

If you wish to take new pictures, record sounds or video clips, select “Take Picture”, “Record Voice” or “Record Video”.

- When attaching JPEG files, select the appropriate resize option, as the maximum message size for sending varies depending on the service provider.

To Attach a Contacts List Entry

1. In step 5 in “Creating a New Message” on page 50, highlight the “Others” indicator in the lower right of the screen. Press  and select “Attach Contact”.
2. Select the desired entry.

If you wish to select your own Contacts List entry, select “My Contact Details”.

To Attach a Schedule Entry

1. In step 5 in “Creating a New Message” on page 50, highlight the “Others” indicator in the lower right of the screen. Press  and select “Attach Appointment”.
2. Select the desired day including a schedule entry you wish to add.
3. Select the desired schedule entry.

To Remove or Replace Attachments

1. In step 5 in “Creating a New Message” on page 50, press [Options] and select the corresponding remove option for each attachment.

Using the Sending Options

You can use the message sending options for each type of message.

1. Highlight the “Send” indicator in the lower left of the screen, then press  and select “Message Settings”.
 - “Read Report” (“On”, “Off”) (MMS): Confirms whether or not a report is sent notifying the sender that the message has been read.
 - “Delivery Report” (“On”, “Off”) (SMS/MMS): Enables or disables Delivery Report when the message is successfully sent to the recipient.
 - “Expiry Time” (“Maximum”, “30 minutes”, “1 hour”, “6 hours”, “1 day”, “1 week”) (SMS/MMS): Sets Expiry Time for a message to be saved in the server.
 - “Priority” (“High”, “Normal”, “Low”): Prioritises composed messages.
 - “Delivery Time” (“No delay”, “30 minutes”, “1 hour”, “6 hours”, “1 day”, “1 week”) (SMS/MMS): Sets the amount of time before the message is delivered.

2. Highlight the “Send” indicator in the lower left of the screen. Press  and select “Send Message”.

After the message is sent, the message is moved to the Sent box.

Note

- The current message size displayed while you are creating the message is an approximation.
- If a message cannot be sent for some reason, the message stays in the Outbox and the “” is displayed in standby.

Tip

- To save the message without sending, press [Options] and select “Save to Drafts” in step 5 in “Creating a New Message” on page 50.
- You can send the following items attached to multimedia messages. Details are given in the following sections.
 - My Items data
 - Contacts List entry
 - File (Schedule entry created by Calendar, Contacts List entry), etc.
- You can use the template option to help you compose messages. For details on using this option, see “Using Templates” on page 31.

Sending a Message in the Drafts Box (M 4–3)

 → “Drafts”

1. Select the desired tab, SMS/MMS or Email.
2. Press [Options] and select “Edit & Send”.
3. Modify the message, if necessary.
4. Highlight the “Send” indicator in the lower left of the screen. Press  and select “Send Message”.



Sending a Voice Clip Message or Video Clip Message (M 4–1–2) (M 4–1–3)

You can record a new voice or video clip when creating a new message.

Select the appropriate option.

 → “Create Message” → “Voice Message”

 → “Create Message” → “Video Message”

1. Press  to start recording.
2. Press  to stop recording.
3. Select “Accept” to attach to the new message.

The file is saved in the corresponding folder in My Items. For further procedures, see “Creating a New Message” on page 50.

Reading Messages

Messages you receive are saved in the Inbox.

☰ → **"Inbox"**

1. Select the message you wish to view.

Storing the Phone Number of a Sender in the Contacts List

☰ → **"Inbox"**

1. Highlight the message from which you wish to store the phone number or Email address.
2. Press [Options] and select "Save Address".

The new Contacts List entry screen including the phone number is displayed. For details on creating a new Contacts List entry, see "Add New Contact" on page 35.

Calling the Phone Number of a Sender Embedded in the Message

☰ → **"Inbox"**

1. Highlight the message including the phone number you wish to dial.
2. Press [Options] and select "Call Sender".

Downloading a Single MMS

☰ → **"Inbox"**

1. Highlight the message alert (✉) you wish to download.
2. Press [Options] and select "Download".

Tip

- You can download multiple messages at the same time. See "Downloading Multiple MMS".

Downloading Multiple MMS

☰ → **"Inbox"**

1. Press [Options] and select "Advanced".
2. Select "Multiple Select".
3. Select the desired message alert, press [Options] and select "Select" or "Select All".
4. Press [Options] and select "Download".

The selected messages are downloaded at the same time.

Replying to a Message or to All Addresses

☰ → ***“Inbox”***

1. Highlight the message the sender of which you wish to reply to.
2. Press [Options] and select “Reply” or “Reply All”.
3. Select “Reply” or “Reply with History”.
4. Enter the message.
5. Highlight the “Send” indicator in the lower left of the screen. Press  and select “Send Message”.

Forwarding a Message

☰ → ***“Inbox”***

1. Highlight the message you wish to forward.
2. Press [Options] and select “Forward”.
3. Perform steps 1 to 6 in “Creating a New Message” on page 50.

Sorting the Messages in the List

☰ → ***“Inbox”***

1. Press [Options] and select “Advanced”.
2. Select “Sort”.
3. Select the desired sort type.

Locking or Unlocking the Messages

☰ → ***“Inbox”***

1. Highlight the message you wish to lock or unlock.
2. Press [Options] and select “Advanced”.
3. Select “Lock” or “Unlock”.

Sending a Picture File with Postcard (M 4–1–4)

Your phone allows you to send multimedia messages to a Vodafone specific Postcard service centre that prints the picture and mails it to the recipient’s home address specified in the MMS message. (Your phone is initially provided with the address of a Vodafone specific Postcard service centre, and its address cannot be changed.)

Note

- *This service is not available with some service providers. Please contact your service provider for more information.*

To Create a New Postcard

See the note on page 133 for menu indications.

☰ → **“Create Message”** → **“Postcard”** → **“Saved Pictures”**

1. Select a picture you wish to send.

If you wish to take new pictures, select “Take Picture”.

If the file size of selected JPEG format pictures or taken pictures is too large to send, resize the picture and try again.

2. Enter your message.

You can enter messages of up to 200 bytes.

3. Enter or select the recipient.

See the note below for details.

- “Name” (mandatory):
Name of the recipient for a postcard up to 50 bytes
- “Additional Information” (optional):
Additional information of the recipient up to 50 bytes
- “Street & Number” (mandatory):
Street and number up to 50 bytes
- “City” (mandatory):
City up to 50 bytes
- “Postal Code” (optional):
Postal code up to 20 bytes
- “State/Province” (optional):
State, province, and region up to 50 bytes
- “Country” (optional):
Country up to 20 bytes

4. Press [Options] and select “Send Postcard”.

Note

- The items “Name”, “Street & Number” and “City” are necessary to complete sending Postcards.
- The items displayed differ according to the service. Please contact your service provider for more information. The item “Country” may not be displayed, so you cannot send Postcards overseas from your phone.
- Asterisks entered in the message or the address become invalid when the message is sent, and spaces cannot be entered in the Postal Code.
- Files in Animation GIF format cannot be used for the Postcard service.
- The picture quality of Postcards varies depending on the picture size.

Messaging Settings (M 4–9)

General Settings (M 4–9–1)

☰ → “*Messaging Settings*” → “*General Settings*”

1. Select the item you wish to set up.

- “Home Download”:
Controls message download timing inside your network area.
“Always Download”: Downloads messages immediately from the server.
“Always Defer”: Defers message download.
- “Roaming Download”:
Controls message download timing when roaming outside of your network.
“Always Download”: Downloads messages immediately from the server.
“Always Defer”: Defers message download.
- “Delivery Report”:
Enables or disables Delivery Report request.
- “Read Report”:
Enables or disables Read Report request.
- “Expiry Time”:
This indicates the number of days and hours for which a message you send may remain undelivered to the message recipient. During this period, the message service centre will continually try to deliver the message to the recipient.
- “Delivery Report Allow”:
Confirms whether or not a report is sent notifying the sender when you receive an MMS/SMS.
- “Read Report Allow”:
Enables or disables Read Report Allow when the recipient is required to inform the sender that the message has been read.
- “Edit Signature”:
Opens the screen to enter the signature.
- “Auto Delete”:
Deletes the oldest message automatically when the Inbox, Sent or both (Inbox and Sent) is full.
- “Automatic Resend”:
Tries to resend the failed SMS/MMS message up to two times (“On” or “Off” selection).
- “Message List View”:
Switches the mailbox listing between “One-line View” and “Two-line View”.

SMS Settings (M 4–9–2)

☰ → “**Messaging Settings**” → “**SMS Settings**”

1. Select the item you wish to set up.

- “**Message Centre**”:
Enter the message centre number.
If you wish to enter a country code for a message to an international number, press and hold **[0+]** until a + sign is displayed.
- “**Message Format**”:
Select the message format to be used when creating a new message.
- “**Reply Path**”:
Accepts or rejects the same reply path with the send path when receiving the reply message for your message.
- “**Optimisation**”:
When set “On” (default), double-byte characters such as European characters with an accent are converted into single-byte characters and sent.
When “Off”, double-byte characters are sent as displayed.
Please note that you may be charged double for double-byte characters sent in an SMS when Optimisation is set “Off”.

MMS Settings (M 4–9–3)

☰ → “**Messaging Settings**” → “**MMS Settings**”

1. Select the item you wish to set up.

- “**MMS Accounts**”:
Select the desired account or select “Create New” to enter the following settings.
“Profile Name”: MMS profile name (Unique name)
“Proxy”: Proxy setting for MMS
“Relay Server URL”: MMS relay server
- “**Slide Duration**”:
Sets the duration of the slide.
- “**Max Message Size**”:
Sets the maximum message size for sending and disables sending MMS messages exceeding that size.
- “**Creation Mode**”:
When set to “Free”, you can attach files of any format to the mail. When set to “Restricted”, only certain formats and message sizes can be attached. The “Restricted” setting has priority over “Max Message Size”.

Email Settings (M 4–9–4)

☰ → **“Messaging Settings”** → **“Email Settings”**

1. Select the item you wish to set up.

- **“Email Accounts”:**
Select the desired account or select “Create New” to enter the following settings.
 - “Account Name”: Email account name (Unique name)
 - “POP3 Server”: Server name, user ID, password and port number for POP3 server
 - “SMTP Server”: Server name, user ID, password, port number for SMTP server and SMTP Authentication
 - “Access Point”: Access point for Email
 - “Email Address”: Email address
- **“Download Interval”:**
Sets the download interval.
- **“Max Message Size”:**
Sets the maximum message size for sending and disables sending Email messages exceeding that size.

Cell Broadcasts (M 4–9–5)

You can receive cell broadcast messages or general messages such as weather forecasts and traffic reports. This information is broadcast to subscribers in certain network areas.

This function may not be available on all mobile phone networks. Contact your service provider for more information.

To Enable/Disable Cell Broadcasts

☰ → **“Messaging Settings”** → **“Cell Broadcasts”** → **“Switch On/Off”**

1. Select “On” or “Off”.

To Read Cell Broadcast Messages



☰ → **“Messaging Settings”** → **“Cell Broadcasts”** → **“Read Messages”**

1. Select the desired subject.
2. Scroll the screen to read the message.
3. Press [Back].

To Set Languages for Cell Broadcast Messages

☰ → **“Messaging Settings”** → **“Cell Broadcasts”** → **“Settings”** → **“Language”**

The current language is displayed.

1. Press .
2. Press  to check.
3. Press [Save].

To Subscribe to Cell Broadcasts

Select the page of the cell broadcast message that you want.

☰ → **“Messaging Settings”** → **“Cell Broadcasts”** → **“Settings”** → **“Set Info Subjects”** → **[Options]**

1. Select “Add/Remove”.
2. Select the desired page.
3. Press [Back].

Tip

- If the desired page is not in the list that appears in step 2, select “Create Subject” in step 1, then enter the subject code to add a page. For details on the subject code, contact your service provider.

Area Info (M 4–9–6)

The Area Info is the message information that operators send to subscribers in certain areas.

When you receive Area Info, the message (area code) is displayed in standby.

To Enable/Disable Area Info

☰ → **“Messaging Settings”** → **“Area Info”**

1. Select “On” or “Off”.

Note

- This function may not be available on all mobile phone networks. Contact your service provider for more information.
- If Area Info is set to “On”, the standby time will decrease.

Vodafone live! (M 2)

Your phone is already configured to access Vodafone live! and the mobile internet*.



Vodafone live! is a new mobile internet portal which is your gateway to a new world of information, games, music and services.

Because your phone uses 3G (UMTS), it has a system that is much faster than previous ways of getting mobile information. Also, the connection is 'always on' which means there is no need to wait for dialling up. You only have to pay for the data you send or receive, not how long you're connected.

* If you have problems getting connected, please phone Vodafone Customer Support.

Your phone contains a WAP browser used for surfing on the Mobile Internet, where you can get a lot of useful information. Normally, pages are designed for a mobile phone.

Main Menu

"Vodafone live!" → ***"Vodafone live!"***

The Vodafone live! service page is displayed.

"Vodafone live!" → ***"Enter URL"***

The URL entry screen is displayed, allowing you to jump to a site.

"Vodafone live!" → ***"Bookmarks"***

See page 61.

"Vodafone live!" → ***"Alert Inbox"***

WAP Push alerts are displayed.

"Vodafone live!" → ***"My Saved Page"***

The saved screenshots are displayed.





"Vodafone live!" → ***"Access History"***

The history of pages you have recently browsed is displayed.

"Vodafone live!" → ***"Browser Settings"***

See page 61.

Navigating a WAP Page

- : Move the highlights around in the screen.
- : Executes the option displayed in the lower centre of the screen.
- : Launches the browser option menu.
- : Selects an action displayed in the lower right of the screen.
Used to access “Vodafone live!” by opening the browser.
-  (short press): Exits the browser.
(press and hold): Turns off the phone.

Editing Bookmarks (M 2–3)

“Vodafone live!” → “Bookmarks”

1. Select the desired URL, and press [Options].

You can edit the list of Bookmarks by the following options:

- “Open”: Selects a bookmark.
- “Details”: Displays detailed information of the WAP page.
- “Send Page”: Sends the URL address to recipients.
- “New”: Creates new folders or bookmarks.
- “Rename”: Renames bookmarks.

- “Edit URL”: Edits URL address of the bookmark.
- “Move”: Moves bookmarks to another location.
- “Delete”: Deletes a bookmark.
- “Delete All”: Deletes all bookmarks.

Browser Settings (M 2–7)

“Vodafone live!” → “Browser Settings”

- “Font Size”: Sets the size of the browsing font.
- “Scroll Step”: Sets the speed of scrolling.
- “Send Referrer”: Enables or disables the notification of the referrer.
- “Cookies”: Adjusts the setting of cookies.
- “Downloads”: Disables downloading data from the images/sounds/objects.
- “Security”: Adjusts the security prompt level.
- “WAP Push”: Sets whether you need confirmation for push message.
- “Download to”: Sets the download location.

The Browser Options

You can use various options of the WAP browser.

☉ → **[Options]**

“Select”:	Selects a WAP page.
“Home”:	Goes to the homepage.
“Bookmarks”:	See page 61.
“Mark Page”:	Marks the selected WAP page.
“Save This Link”:	Downloads the linked WAP page data.
“Save Items”:	Saves items from WAP pages.
“Enter URL”:	Goes to the WAP page that you enter the URL address of.
“Access History”:	Shows the history where you have browsed.
“Forward”:	Goes to the next page of the pages displayed.
“Reload Page”:	Reloads the WAP page again to get new information.
“Advanced”:	Displays the advanced menus.
“Exit”:	Exits the browser.

The Advanced Options

☉ → **[Options]** → **“Advanced”**

“My Saved Page”:	The saved screenshots are displayed.
“Save This Page”:	Saves the WAP page as the local file.
“Send Page”:	Sends the URL address and title to recipients.
“Details”:	Shows detailed information of the WAP page.
“Browser Data”:	Edits the browser data. You can clear the cache/cookies/history.
“Search This Page”:	Searches specific words in the WAP page.
“Copy Text”:	Copies the text on the web page.
“Browser Settings”:	Displays the Settings menus.
“Restart Browser”:	Restarts the browser.
“About”:	Displays the browser information.

Music (M 3)

Music Player

You can play back MP3, AAC and AAC+ format sound files with Music Player. While playing back sound files in the background, you can use other menus.

Playing Back Sound Files

“Music” → **“My Music”**

1. Select “All Music” or the desired playlist.

2. Select the desired file.

To pause playback, press .







To stop playback, press [Back].

Note

- You are asked whether or not to play sounds when the Silent mode is activated.
- To play the last played file, select “Last Played Music”. “Currently Playing” is displayed when the file is being played back.

Tip

- You can return to the Main menu screen while playing back the file in the background.
- You can create your playlist by listing only the desired files (p. 64).

- You can make tone adjustment in step 2. Press [Options] and select “Tone Control”. Select “Normal”, “Bass”, “Surround” or “Surround Bass”.
- You can select the playback pattern in step 2. Press [Options] and select “Playback Pattern”.
 - “Normal”: Plays back all files in the selected folder once and stops playback.
 - “Repeat”: Continues playback in the selected folder.
 - “Repeat All”: Plays back all files in the selected folder.
 - “Random”: Plays back files in the selected folder at random.
- You can control the Music Player by using the following keys:
 -  : Increases or decreases the volume.
 -  (press and hold): Mutes.
 -  : Jumps to the next file.
 -  : Returns to the top portion of the current file.
 -  (press and hold): Fast–forwards.
 -  (press and hold): Rewinds.
 -  : Plays back the file in the background.

Searching a File to Be Played Back

“Music” → **“My Music”**

1. Select “All Music” or the desired playlist.
2. Press [Options] and select “Search”.
3. Enter the first few letters of the title.

Search results are displayed in alphabetical order and the matching file is highlighted.

Adding a File to the Playlist

You can create a playlist registering desired files.

“Music” → **“My Music”** → **“All Music”**

1. Highlight the file you wish to add to the playlist.
2. Press [Options] and select “Add to Playlist”.
The playlists are displayed. For details on adding a playlist, see “Adding a New Playlist”.
3. Select the desired folder.

The file highlighted in step 1 is saved.

To delete files from the playlist, highlight the file and press [Options]. Then select “Delete from Playlist”.

Adding a New Playlist

“Music” → **“My Music”**

1. Press [Options] and select “Add New Playlist”.
2. Enter the desired playlist name.
3. Press .

Note

- To delete the playlist, highlight the playlist and press [Options]. Then select “Delete Playlist”.

Downloading the Music Files (M 3–3)

“Music” → **“Browse Music Store”**

The music file download site is displayed.

Note

- This service is not available with some service providers. Please contact your service provider for more information.

My Items (M 6)



My Items contains several types of picture, sound and video clip data. Also included in My Items are frequently used text message phrases and WAP sites which you can use for downloading. You can also transmit picture, sound and video clip data via infrared or *Bluetooth* wireless technology to OBEX-enabled phones.

Pictures (M 6–1)

Pictures that are taken by a digital camera or images that are downloaded from mobile Internet sites can be managed. You can register pictures in the following formats: JPEG, PNG, WBMP and GIF.

Viewing Pictures

“My Items” → “Pictures”

1. Press  to display the list from the memory card and  to return to the handset memory.
2. Select the file you wish to view.

The selected picture is displayed.

Using Images as Wallpaper

“My Items” → “Pictures”

1. Highlight the file you wish to use as wallpaper.
2. Press [Options] and select “Set as Wallpaper”.

Saving an Image to Contacts List Entries

You can use this option only for pictures saved in the handset memory.

“My Items” → “Pictures”

1. Highlight the file you wish to add to Contacts List.
2. Press [Options] and select “Add to Contact”.

To overwrite, select the data you wish to save.

To save as a new entry, select “As New Contact”.

For details on entering a name, see “Add New Contact” on page 35.

Editing Pictures

“My Items” → “Pictures”

1. Highlight the file you wish to edit.
2. Press [Options] and select “Picture Editor”.
3. Select the desired option.

Note

- *“Picture Editor” may not be available depending on the original picture and copyright issued.*

Adjusting the Size

You can adjust the picture to an appropriate size depending on the scene.

“My Items” → “Pictures”

1. Highlight the file you wish to adjust the size of.
2. Press [Options] and select “Resize”.
3. Select the desired option.

Note

- “Resize” may not be available depending on the original picture and copyright issued.

Tip

- For other option menus, see “Common Option Menus” on page 68.

Downloading Picture Files

“My Items” → “Pictures” → “Get new”



The picture file download site is displayed.

Sounds & Ringtones (M 6–2)

The downloaded sound files and the AMR data recorded by Voice Recorder are managed in Sounds & Ringtones. The default ringtones are not contained within Sounds & Ringtones. Only the sound files that can be played back on the phone are stored in Sounds & Ringtones.

Playing Back Sound Files

“My Items” → “Sounds & Ringtones”

1. Press  to display the list from the memory card and  to return to the handset memory.
2. Select the file you wish to play back.
To stop playback, press .

Note

- Playback may not be available for some sound files.

Using the Sound Files as a Ringtone

“My Items” → “Sounds & Ringtones”

1. Highlight the file you wish to use as a ringtone.
2. Press [Options] and select “Set as Ringtone”.

Note

- AMR format music files cannot be used for ringtones.

Tip

- For other option menus, see “Common Option Menus” on page 68.

Downloading Sound Files

“My Items” → “Sounds & Ringtones” → “Get new”





The sound file download site is displayed.

Videos (M 6–4)

Video clips that are recorded by a video camera or downloaded from mobile Internet sites can be managed.

Playing Back Video Clip Files

“My Items” → **“Videos”**

1. Press  to display the list from the memory card and  to return to the handset memory.
2. Select the file you wish to play back.
3. Press .
To pause playback, press .
To resume, press  again.
To stop playback, press [Back].

Using a Video Clip as a Ring Video

You can set your video clip to play back when the phone rings.

“My Items” → **“Videos”**

1. Highlight the desired video clip.
2. Press [Options] and select “Set as Ring Video”.

Tip

- For other option menus, see “Common Option Menus” on page 68.

Downloading Video Clip Files

“My Items” → **“Videos”** → **“Get new”**



The video clip file download site is displayed.

Other Documents (M 6–6)

Some types of files are stored in the Other Documents folder of the phone. You can edit and use these files as My Items data.

Opening the Document File

“My Items” → **“Other Documents”**

1. Press  to display the list from the memory card and  to return to the handset memory.
2. Select the desired file.

Tip

- For other option menus, see “Common Option Menus” on page 68.

Common Option Menus

Activating Files with Copyright Protection (DRM)

Some pictures, sound files, and video clips have a digital copy protection program, which is called DRM (Digital Rights Management). You need to activate the digital licence permission to open the files. Files protected with DRM are displayed with .

Select the appropriate option.

“My Items” → **“Pictures”**

“My Items” → **“Sounds & Ringtones”**

“My Items” → **“Videos”**

“My Items” → **“Other Documents”**

1. Highlight the file you wish to activate.
2. Press [Options] and select “Activate”.

Note

- Some pictures with DRM may not open even when an attempt is made to activate it.

Sending My Items Data

Select the appropriate option.

“My Items” → **“Pictures”**

“My Items” → **“Sounds & Ringtones”**

“My Items” → **“Videos”**

“My Items” → **“Other Documents”**

1. Highlight the desired file.
2. Press [Options] and select “Send”.
3. Select “As Message”, “As Postcard”, “Via Bluetooth” or “Via Infrared”.

For details on creating a message, see “Creating a New Message” on page 50.

For details on *Bluetooth* wireless settings, see “Bluetooth” on page 111.

For details on Infrared settings, see “Infrared” on page 113.

Note

- Pictures/Sounds/Video clips protected by copyright cannot be sent attached to a message, with the exception of *Separate Delivery files*.
- When pairing, you need to enter your passcode when establishing contact with a Bluetooth wireless technology enabled device for the first time.
- When you send a picture file, select “As Postcard” in step 3. The Postcard service is not available with some providers. Contact your service provider for more information.

Receiving My Items Data

When the phone receives My Items data, a confirmation message is displayed in standby.

1. Press [Yes].

The received data is saved in the corresponding My Items folder.

Tip

- For details on Infrared or Bluetooth wireless settings, see *“Connectivity” on page 111.*

Using My Items Data

You can copy, move, sort, rename, and delete the saved My Items data.

Select the appropriate option.

“My Items” → **“Pictures”**

“My Items” → **“Sounds & Ringtones”**

“My Items” → **“Videos”**

“My Items” → **“Other Documents”**

1. Highlight the desired file.
2. Press [Options] and select “Advanced”.
3. Select the desired option.

“Move”: Moves files to another folder. Select the desired folder to move to.

“Copy”: Copies files. Select the desired folder to copy to.

“Create Folder”: Creates a new folder.

“Multiple Select”: Selects multiple files.

“Sort”: Sorts the file. Select the desired files to sort.

To Rename the File

Select the appropriate option.

“My Items” → **“Pictures”**

“My Items” → **“Sounds & Ringtones”**

“My Items” → **“Videos”**

“My Items” → **“Other Documents”**

1. Highlight the desired file.
2. Press [Options] and select “Rename”.

To Delete the File

“My Items” → **“Pictures”**

“My Items” → **“Sounds & Ringtones”**

“My Items” → **“Videos”**

“My Items” → **“Other Documents”**

1. Highlight the desired file.
2. Press [Options] and select “Delete”.

To See the My Items Details

Select the appropriate option.

“My Items” → **“Pictures”**

“My Items” → **“Sounds & Ringtones”**

“My Items” → **“Videos”**

“My Items” → **“Other Documents”**

1. Highlight the file you wish to view the details of.
2. Press [Options] and select “Details”.

Uploading My Items Data

You can upload your picture, sound or video clip files to the Media Album.

“My Items” → **“Pictures”**

“My Items” → **“Sounds & Ringtones”**

“My Items” → **“Videos”**

1. Highlight the file you wish to upload.
2. Press [Options] and select “Send”.
3. Select “To Media Album”.

Note

- This service is not available with some service providers. Please contact your service provider for more information.
- Picture, sound and video clip files protected with a copyright cannot be uploaded, with the exception of Separate Delivery files.

Selecting Multiple Files

You can select more than one item from My Items for moving, copying and deleting.

Note

- The following procedure applies when the entries other than “Get new” are highlighted.

Select the appropriate option.

“My Items” → **“Pictures”** → [Options]

“My Items” → **“Sounds & Ringtones”** → [Options]

“My Items” → **“Videos”** → [Options]

“My Items” → **“Other Documents”** → [Options]

1. Select “Advanced”.
2. Select “Multiple Select”.
3. Press to check the desired file names.
4. Press [Options] and select the desired option.

Tip

- To remove the check, select the file again or select “Unselect” in step 4.
- If you wish to select all files, select “Select All” in step 4. To unselect all, select “Unselect All”.

Games & Applications (M 6–3)

For details on Vodafone specific applications, see “Games & Applications” on page 72.

Text Templates (M 6–5)

You can register up to 50 text templates for use in text messages and multimedia messages. A maximum of 256 characters can be used for a single text template.

Adding Phrases to Text Templates

“My Items” → “Text Templates” → “Add New Template”

1. Enter the text and press .

Editing Text Templates

“My Items” → “Text Templates”

1. Highlight the text template you wish to edit.
2. Press [Options] and select “Edit”.

To view the text template, press [Options] and select “View”.

To delete the text template, press [Options] and select “Delete”.

3. Modify the text and press .

Sending Text Templates

“My Items” → “Text Templates”

1. Highlight the text template you wish to send.
2. Press [Options] and select “Send Template”.

Memory Status (M 6–7)

This function helps you to check the memory status of the handset memory or memory card. Memory status covers the following.

Handset Memory: Applications, Pictures, Videos, Sounds, Others, Total and Free

Memory Card: Pictures, Videos, Sounds, Others, Total and Free

“My Items” → “Memory Status”

1. Select “Handset Memory” or “Memory Card”.

Entertainment (M 1)

Games & Applications (M 1–1)

Using Applications (M 1–1–1)

Various kinds of Vodafone specific applications can be used on this phone. To use applications, download the applications via the mobile Internet. Some applications offer the ability to connect to a network either within a game or a network based application.

Note



- *Applications may be both localised (no connectivity) and network based (using the mobile Internet to update information/play games). The network may charge you more for using network-based applications. Please contact your service provider for more information.*

Downloading Applications

“Entertainment” → **“Games & Applications”** → **“Games & Applications”** → **“More Games”**

1. Select the desired application.

Before downloading the application you are asked to confirm what you are about to receive. After checking the information on the confirmation screen, the application can be downloaded.

2. Press  to start downloading.
3. Press  when finished.

Note

- *User authentication may be required before downloading the application on some information screens.*

Executing Applications

“Entertainment” → **“Games & Applications”** → **“Games & Applications”**

1. Select the title of the application you wish to execute.

The selected application is executed. When using network connection type applications, connection to the network can be selected.

2. To end the application, press  and select “End”.

Setting as a Screensaver for the Main Display

“Entertainment” → **“Games & Applications”** → **“Games & Applications”**

1. Highlight the file you wish to use as a screensaver.
2. Press [Options] and select “Set as Screensaver”.

Setting Permission

You can set permission for selected Java™ applications.

“Entertainment” → “Games & Applications” → “Games & Applications”

1. Highlight the desired Java™ application.

2. Press [Options] and select “Permission”.

3. Select one of the following options:

- | | |
|---------------------|---|
| “Phone Call”: | Sets permission to make voice calls. |
| “Network Access”: | Sets permission to access the network. |
| “Messaging”: | Sets permission to perform MMS and SMS messaging. |
| “Autorun”: | Sets permission to perform the Autorun function. |
| “Local Connection”: | Sets permission to connect to local devices. |
| “Read User Data”: | Sets permission to read user data, such as Contacts List entries, mailbox (Inbox) and My Items data. |
| “Write User Data”: | Sets permission to write entries in your phone, such as Contacts List entries, mailbox (Inbox) and My Items data. |
| “Use Multimedia”: | Sets permission to use the multimedia recording. |
| “Location Access”: | Sets permission to update the positioning function. |

4. Select one of the following options:

- | | |
|-------------|--|
| “Session”: | The confirmation message is not displayed until you exit the application, while execution of the API of the specified function group is authorised. |
| “Ask Once”: | The confirmation message is displayed every time the API of the specified function group is executed. |
| “Blanket”: | The confirmation message is not displayed until the application is deleted or you change the settings, while execution of the API of the specified function group is authorised. |
| “No”: | Execution of the API of the specified function group is not authorised. |

Note

- To clear all the permission settings, select “Reset” in step 3.
- All permissions are not available for all Java™ applications.

Viewing Application Information

You can check the information of Java™ applications.

“Entertainment” → **“Games & Applications”** → **“Games & Applications”**

1. Highlight the desired Java™ application.
2. Press [Options] and select “Information”.

Deleting an Application

You can delete an application from the handset memory.

“Entertainment” → **“Games & Applications”** → **“Games & Applications”**





1. Highlight the desired Java™ application.
2. Press [Options] and select “Delete”.

Settings (M 1–1–2)

Application Volume

You can set the volume of the application such as the sound effect to one of the five levels or silent. When the profile is set to “Silent”, the “General Volume” setting (p. 93) has priority.

“Entertainment” → **“Games & Applications”** → **“Settings”** → **“Application Volume”**

1. Press  (or ) to increase the volume or press  (or ) to decrease the volume and then press .

Backlight

“Entertainment” → **“Games & Applications”** → **“Settings”** → **“Backlight”** → **“Switch On/Off”**

1. Select “Always On”, “Always Off” or “Normal Settings”.
 - “Always On”: Lit while the application is operated.
 - “Always Off”: Unlit while the application is operated even if a key is pressed.
 - “Normal Settings”: Works with the main backlight setting (p. 99).

To Set the Blinking Operation

This setting enables the backlight to be controlled by the application. If set to “Off”, the backlight cannot be turned on from the application.

“Entertainment” → **“Games & Applications”** → **“Settings”** → **“Backlight”** → **“Blink”**

1. Select “On” or “Off”.

Vibration

When the vibrator is set in the application, you can choose whether the operation is enabled or disabled.



“Entertainment” → **“Games & Applications”** → **“Settings”** → **“Vibration”**

1. Select “On” or “Off”.

Calls & Alarms

You can set the priority of incoming calls and alarms while an application is operating.

“Entertainment” → **“Games & Applications”** → **“Settings”** → **“Calls & Alarms”**

1. Select “Voice Call”, “Video Call”, “Incoming Message” or “Alarm”.
2. Select the desired method.
 - “Call Priority”, “Message Priority” or “Alarm Priority”:
The application is suspended automatically, and you can receive a call or a message, or the alarm will sound. After finishing the call or the message, or the alarm ends, the suspend indicator () is displayed letting you know there is a suspended application.
 - “Call Notice”, “Message Notice” or “Alarm Notice”:
The marquee (character scrolls) is displayed on the first line of the screen while the application continues. If you press , the application is suspended, and you can receive a call or a message. After finishing the call or the message, the suspend indicator () is displayed letting you know there is a suspended application.

Screensavers

You can download screensaver applications for the standby screen and set the time period for the screensaver to activate.

“Entertainment” → **“Games & Applications”** → **“Settings”** → **“Screensavers”** → **“Switch On/Off”**

1. Select “On” or “Off”.

For further procedures, see “Setting as a Screensaver for the Main Display” on page 72.

To Set the Activation Time

“Entertainment” → **“Games & Applications”** → **“Settings”** → **“Screensavers”** → **“Activation Time”**

1. Enter the activation time in two digits using the keypad.

To Set the Suspend Time

“Entertainment” → **“Games & Applications”** → **“Settings”** → **“Screensavers”** → **“Suspend Time”**

1. Set the desired time period from “after 15 min.” to “after 6 hours”.

Setting the Surround Sound

“Entertainment” → **“Games & Applications”** → **“Settings”** → **“Surround”**

1. Select “On” or “Off”.

Default Settings

All the settings for “Games & Applications” can be reset.

“Entertainment” → **“Games & Applications”** → **“Settings”** → **“Set to Default”**

1. Enter your handset code.

Clearing All Memory

The Java™ applications in the handset memory can be reset.

“Entertainment” → **“Games & Applications”** → **“Settings”** → **“Memory All Clear”**

1. Enter your handset code.

Java™ Information (M 1–1–3)

“Entertainment” → **“Games & Applications”** → **“Java™ Information”**

The information about the licences belonging to Java™ is displayed.

TV & Video (M 1–2)

Playing Back Video Clip Files (M 1–2–4)

“Entertainment” → **“TV & Video”** → **“My Videos”**







1. Select “Handset Memory” or “Memory Card”.

2. Select the desired file.

To pause playback, press .
To stop playback, press [Back].

Tip

- You can control the Video Player by using the following keys:

- : Increases or decreases the volume.
- : (press and hold): Mutes.
- : Jumps to the next file.
- : Returns to the top portion of the current file.
- : (press and hold): Fast-forwards.
- : (press and hold): Rewinds.

Searching a File to Be Played Back

“Entertainment” → **“TV & Video”** → **“My Videos”**

1. Select “Handset Memory” or “Memory Card”.
2. Select “All Videos” or the desired playlist.
3. Press [Options] and select “Search”.
4. Enter the first few letters of the title.

Search results are displayed in alphabetical order and the matching file is highlighted.

Adding a File to the Playlist

You can create a playlist registering desired files.

“Entertainment” → “TV & Video” → “My Videos”

1. Select “Handset Memory” or “Memory Card”.
2. Select “All Videos” or the desired playlist.
3. Highlight the file you wish to add to the playlist.
4. Press [Options] and select “Add to Playlist”.

The playlists are displayed. For details on creating a playlist, see “Adding a New Playlist”.

5. Select the desired folder.

The file highlighted in step 3 is saved.

To delete files from the playlist, highlight the file and press [Options]. Then select “Delete from Playlist”.

Adding a New Playlist

“Entertainment” → “TV & Video” → “My Videos”

1. Select “Handset Memory” or “Memory Card”.
2. Press [Options] and select “Add New Playlist”.
3. Enter the desired playlist name.
4. Press .

Note

- To delete the playlist, highlight the playlist and press [Options]. Then select “Delete Playlist”.

Editing the Video Clip File

“Entertainment” → “TV & Video” → “My Videos”

1. Select “Handset Memory” or “Memory Card”.
2. Select “All Videos” or the desired playlist.
3. Select the file you wish to edit.
4. Press [Options] and select “Edit”.
5. Select the desired option.

“Crop”: Selects the desired area to be cropped.

“Subtitle”: Creates a subtitle to add to the file.

Settings

You can select a play mode for “Playback Pattern”, “Backlight” and “Display Size” when playing back video clip files.



“Entertainment” → **“TV & Video”** → **“My Videos”**

1. Select “Handset Memory” or “Memory Card”.
2. Select “All Videos” or the desired playlist.
3. Select the file for which you wish to adjust the play mode.
4. Press [Options] and select “Settings”.
5. Select “Playback Pattern”, “Backlight” or “Display Size”.
6. Select from the following:
 - “Playback Pattern”
 - “Normal”: Plays back all files in the selected folder once and stops playback.
 - “Repeat”: Continues playback in the selected folder.
 - “Repeat All”: Plays back all files in the selected folder.
 - “Random”: Plays back files in the selected folder at random.
 - “Backlight”
 - “Always On”: Lit while the file is played back.
 - “Always Off”: Unlit while the file is played back even if a key is pressed.
 - “Normal Settings”: Works with the main backlight setting (p. 99).
 - “Display Size”
 - “Original Size”: Displays the file in its original size.
 - “Enlarge”: Displays the file in an enlarged size.
 - “Full Screen”: Displays the file on the full screen.

SD VIDEO (M 1–2–5)

Video clips that are recorded by a video camera or downloaded from mobile Internet sites can also be managed with SD VIDEO.

“Entertainment” → **“TV & Video”** → **“SD VIDEO”**

1. Select the desired file.
 - To pause playback, press .
 - To stop playback, press .
 - To delete files from the playlist, highlight the playlist, press [Options] and select “Delete”.

Downloading Video Clip Files (M 1–2–3)

“Entertainment” → **“TV & Video”** → **“Get New Videos”**

The video clip file download site is displayed.

Playing Back the Video Clip Files

To Play Back the Last File (M 1–2–1)

“Entertainment” → **“TV & Video”** → **“Last Played Video”**

Streaming (M 1–2–2)

You can play back video clip files while downloading them from the mobile network.

You can also register the address of the Web site as a bookmark.

“Entertainment” → “TV & Video” → “Streaming”

1. Select “Last Played Streaming”, “Enter URL”, “Favourites”, “Access Log” or “Display Size”.

“Last Played Streaming”:

Shows the last streaming file.

“Enter URL”:

Enter the desired address of the Web site. The browser opens, starts downloading and plays back.

“Favourites”:

The address of the Web site is registered.

“Access Log”:

Shows the logs of the Web site you accessed. From the log you can start streaming.

“Display Size”:

Select “Original Size”, “Enlarge” or “Full Screen”.

Organiser & Tools (M 7)

Calendar (M 7–1)

Calendar allows you to easily schedule appointments or events at any given date or time.

These entries can also be sent via Infrared or *Bluetooth* wireless technology to a PC to share the same schedules. When you exchange entries with other devices, the date and time displayed may be different to that of the original data depending on the data format of the receiving device.

Creating a New Entry

“Organiser & Tools” → **“Calendar”**

1. Select the desired day to which you want to add an event.
2. Select “Add New Entry”.
3. Enter the subject.
4. Enter the location.
5. Select the desired category.
6. Enter the start date and then enter the start time.
7. Select the duration.

When selecting “Other”, enter the desired end date and time.

8. Select the reminder time.

When selecting “Other”, enter the desired reminder date and time.

9. Press [Save].

Note

- If the date and time settings have not been entered, the date and time entry screen is displayed (p. 100).
- The reminder will not sound when “General Volume” (p. 93) is set to “Silent”.

To Change the Type of the Reminder Tone or Video

1. On the New Entry screen, select “Reminder”.
2. Select “Assign Tone/Video”.
3. Select “Assign Tone” and then select “Preset Sounds” or “My Sounds”, or select “Assign Video”.
4. Select the desired sound or video clip file.

For details on selecting a tone, see “Assigning a Ringtone” on page 94.

To Change the Duration of the Reminder Tone or Video

1. On the New Entry screen, select “Reminder”.
2. Select “Duration”.
3. Select the time period.

When you select “Other”, you can enter the desired time in two digits using the keypad.

To Change the Repeat Option of the Reminder

1. On the New Entry screen, select “Repeat”.
2. Select the desired repeat option.

To Enter the Description

1. On the New Entry screen, select “Description”.
2. Enter a memo for the schedule entry.

To Make the Entry Secret

1. On the New Entry screen, select “Secret”.
2. Select “On” to make the data secret or select “Off” to leave it as it is.

Viewing a Schedule Entry

“Organiser & Tools” → “Calendar”

1. Select the day you wish to view.

To Search By Date

1. In any view, press [Options] and select “Go to”.
2. Select “Today” to display today or “Enter Date” to enter the desired date.

Tip

- In the monthly or weekly view, you can control the view by using the following:

Monthly view

 : Displays the previous month.

 : Displays the next month.

 : Displays the weekly view.

 : Moves the cursor to today.

 : Moves the cursor to left (the previous day) or to right (the next day).

 : Moves the cursor upward (last week) or downward (next week).

Weekly view

 : Displays the previous week.

 : Displays the next week.

 : Displays the monthly view.

 : Moves the cursor to today.

 : Moves the cursor to left (the previous day) or to right (the next day).

 : Moves the weekly view up or down (the previous hour or next hour).

Editing a Schedule Entry

“Organiser & Tools” → “Calendar”

1. Select the day and the desired entry you wish to edit.
2. Press [Options] and select “Edit”.
3. Select the desired item and modify the entry.
4. Press [Save].

Deleting Schedule Entries

1. In any view, press [Options] and select “Delete”.
2. Select the desired option.

“This Appointment” (daily view):

Deletes the selected entry.

“All This Day”: Deletes all entries for the selected day.

“All This Week” (weekly view):

Deletes all entries for the selected week.

“Up to Last Week” (weekly view):

Deletes all entries before this week.

“All This Month” (monthly view):

Deletes all entries for the selected month.

“Up to Last Month” (monthly view):

Deletes all entries before this month.

“All Appointments” (weekly and monthly view):

Deletes all entries in this application.

Sending a Schedule Entry

“Organiser & Tools” → “Calendar”

1. Select the day and the desired entry including schedule entries you wish to send.
2. Press [Options] and select “Send”.
3. Select “As Message”, “Via Bluetooth” or “Via Infrared”.

For details on creating a message, see “Creating a New Message” on page 50.

For details on *Bluetooth* wireless settings, see “Bluetooth” on page 111.

For details on Infrared settings, see “Infrared” on page 113.

Note

- When pairing, you need to enter your passcode when establishing contact with a Bluetooth wireless technology enabled device for the first time.

Receiving a Schedule Entry

When the phone receives a schedule entry, a confirmation message is displayed in standby.

1. Press [Yes].

The received entry is saved in the Calendar.

Press [No] to reject.

Tip

- For details on entering Infrared or Bluetooth wireless settings, see “Connectivity” on page 111.

Viewing the Memory Status

1. In any view, press [Options] and select “Memory Status”.

Alarms (M 7–2)

Setting the Alarms

The alarm function allows you to be alerted at a specified time.

Note that you need to set the current date and time before setting the alarm function if it has not been done already.

“Organiser & Tools” → “Alarms”

1. Select the blank setting.
2. Enter the desired time.
3. Press [Save].

To Change the Type of Repeat Options

1. On the Set Alarm screen, select “Repeat”.
2. Select “Once Only”, “Every Day” or “Selected Days”.

“Once Only”:	The alarm sounds once only.
“Every Day”:	The alarm sounds every day at the specified time.
“Selected Days”:	The alarm sounds on the selected day of the week at the specified time.

To Change the Type of Alarm Tone or Video Clip File





1. On the Set Alarm screen, select “Assign Tone/Video”.
2. Select “Assign Tone” and then select “Preset Sounds” or “My Sounds”, or select “Assign Video”.
3. Select the desired tone or video clip file.

For details on selecting a tone, see “Assigning a Ringtone” on page 94.

To Change the Snooze of the Alarm Tone

1. On the Set Alarm screen, select “Snooze”.
2. Select the desired snooze option.

To Change the Alarm Volume

1. On the Set Alarm screen, select “Alarm Volume”.
2. Press  (or ) to increase the volume or press  (or ) to decrease the volume.

Note

- *The alarm will not sound when “Alarm Volume” is set to “Silent”. When the profile is set to “Silent”, the “General Volume” setting (p. 93) has priority.*

To Change the Vibration of Alarm Tone

1. On the Set Alarm screen, select “Vibration”.
2. Select “On”, “Link to Sound” or “Off”.

For details on selecting a vibration, see “Vibration” on page 96.

To Change the Duration of the Alarm Tone

1. On the Set Alarm screen, select “Duration”.
2. Select the desired duration.

Resetting an Alarm Setting

“*Organiser & Tools*” → “*Alarms*”

1. Highlight the alarm you wish to reset.
2. Press [Options] and select “Reset Alarm”.

Resetting All Alarm Settings

“*Organiser & Tools*” → “*Alarms*”

1. Select “Clear All”.

Calculator (M 7-3)

The calculator function performs the 4 arithmetic calculations using up to 12 digits.

“*Organiser & Tools*” → “*Calculator*”

Key operations for calculation are as follows:



To enter a decimal point, press $\boxed{.}$.

To clear the entered number or function, press $\boxed{C/CE}$.

To do the calculations, press $\boxed{=}$.

To start a new calculation, press $\boxed{C/CE}$.

Rate Conversion

You can also use the calculator as a currency calculator to convert from/to a home currency using a conversion rate that you enter.

To Set a Currency Conversion Rate

“Organiser & Tools” → **“Calculator”** → **[Options]** → **“Currency Converter”** → **“Exchange Rate”**

1. Select “Domestic” or “Foreign”.
2. Enter the currency conversion rate.

To Convert a Value

“Organiser & Tools” → **“Calculator”**



1. Enter the value to be converted.
2. Press [Options] and select “Currency Converter”.
3. Select “Convert to Domestic” or “Convert to Foreign”.

Voice Recorder (M 7–4)





This allows you to record a voice clip, which can be used to remind you of schedule entries or be sent within a multimedia message. The recorded voice clip is saved in Saved Sounds. Voice clips are saved in AMR format.

Recording a Voice Clip

“Organiser & Tools” → **“Voice Recorder”**



1. Press  to start recording.
To stop recording before the recording time is over, press .
2. Select “Save” to save the voice clip.

Note

- Press  (or ) or  (or ) to adjust the sound volume when playing back the recorded file.

Sending Voice Clips

“Organiser & Tools” → **“Voice Recorder”**

1. Press  to start recording.
2. Press  to stop recording.
3. Select “Save and Send”.
4. Select “As Message”.

For details on creating a message, see “Creating a New Message” on page 50.

Selecting the Record Time

“Organiser & Tools” → **“Voice Recorder”** → **[Options]** → **“Record Time”**

1. Select “For Message” or “Extended Voice”.
When selecting “Extended Voice”, voice clips are automatically saved to a memory card.

Selecting Storage Memory

“Organiser & Tools” → **“Voice Recorder”** → **[Options]** → **“Save New Sounds”**

1. Select the desired location.
When selecting “Choose bef. Saving”, you can select the location when saving a voice clip.

Scanner (M 7–5)

With the built-in digital camera, you can read texts and barcodes in Jan format and QR codes, and create QR codes. The scanned data can be saved as a Contacts List entry, URL, Email address and text.

Note

- When scanning does not take place, it may be due to one of the following reasons: type or size of barcode, scratches, dirt, damage, print quality, light reflection, etc.

Reading Barcodes

“Organiser & Tools” → “Scanner” → “Scan Barcode”

1. Display the barcode using the external camera.
2. Press .
3. Press [Options] and select the desired option.

The options vary depending on the scanned data.

“Open Link”: The browser opens the URL.

“Copy URL”: The URL is copied.

“Send Message”: The result is sent as SMS or MMS.

“Copy”: The result is copied.

To Use the Continuous Scanning

1. In scanning mode, press [Options] and select “Continuous Scan”.
2. Select “On” or “Off”.

Opening a Barcode Picture

“Organiser & Tools” → “Scanner” → “Open Barcode”

1. Select the desired picture data for barcode.

Viewing the Scanned Data

“Organiser & Tools” → “Scanner” → “Scanned Results”

1. Highlight the data you wish to view, then press .



Creating QR Codes

“Organiser & Tools” → “Scanner” → “Create QR Code”

1. Select the desired option.

“Text Input”: Create a QR code using the text you enter.

“My Items”: Create a QR code using the My Items data.





2. Enter the desired text or select the desired data, then press .
3. Press  to save.

Tip

- The QR code is saved in a PNG format file.

Scanning Text

“Organiser & Tools” → **“Scanner”** → **“Scan Text”**

1. Display text using the camera.
2. When the bar under the scanned text is blue, press .
3. Press  or  to select the desired text, then press .
4. Press [Options] and select the desired option.

“OK”:	The scanned result is in the text entry screen.
“Select/Edit”:	The scanned result can be modified.
“Change Mode”:	The scanned result can be converted to a web address, mail address, phone number or to roman text.

To Use Reversed Text

1. In scanning mode, press [Options] and select “Reversed Text”.
2. Select the desired option from “Auto”, “Normal” or “Reversed”.





E–Book (M 7–6)

This function allows you to view E-Book files (XPDF or Text files) stored in a memory card.

“Organiser & Tools” → **“E–Book”**

1. Select the desired file.

To scroll the screen up and down (to previous or next line), press

 or . To jump to the previous or the following pages, press  or .

2. Press  when finished.

Tip

- When a call arrives while the viewer is on or when you exit an E–Book, “Auto Bookmark1” is automatically added on the last page you have viewed. The page with the bookmark automatically opens when you select the file the next time. The new bookmark is now “Auto Bookmark1”, turning the previous bookmark to “Auto Bookmark2”.

Adding a Bookmark

You can add up to two bookmarks to each E-Book file.

“Organiser & Tools” → **“E–Book”**

1. Select the desired file.
2. Press [Options] and select “Bookmark”.
3. Select “Bookmark1” or “Bookmark2”.

Note

- E–Book files cannot be viewed while “Music” or “Games & Applications” is in use.
- If you remove the memory card while the E–Book is in use, a confirmation message appears and your phone returns to standby.

Stopwatch (M 7–7)

You can store 4 lap times when using the stopwatch function.

“Organiser & Tools” → “Stopwatch”

1. Press  to start.

Press [LAP] to view the lap time before the stopwatch stops. Last 4 lap times are saved.

2. Press  to stop.

Tip

- You can save a record of lap time and stop time in Text Templates by pressing [Options] and selecting “Save to Templates”.

Resetting Time

1. After stopping the stopwatch, press [Options] and select “Reset”.

Tasks (M 7–8)

You can register your schedule as task entries for a given date or time.

Creating a New Entry

“Organiser & Tools” → “Tasks”

1. Select “Add New Entry”.
2. Enter the subject.
3. Enter the due date and then due time.

4. Select the reminder time.

When selecting “Other”, enter the desired reminder date and time.

5. Press [Save].

Note

- If the date and time settings have not been entered, the date and time entry screen is displayed (p. 100).

To Change the Type of Alarm Tone or Video Clip File

1. On the New Entry screen, select “Reminder”.
2. Select “Assign Tone/Video”.
3. Select “Assign Tone” and then select “Preset Sounds” or “My Sounds”, or select “Assign Video”.
4. Select the desired tone or video clip file.

For details on selecting a tone, see “Assigning a Ringtone” on page 94.

To Change the Duration of Alarm Tone or Video

1. On the New Entry screen, select “Reminder”.
2. Select “Duration”.
3. Select the time period.

When you select “Other”, you can enter the desired time in two digits using the keypad.

To Change the Description

1. On the New Entry screen, select “Description”.
2. Enter a memo for the task entry.

To Make the Entry Secret

1. On the New Entry screen, select “Secret”.
2. Select “On” to make the data secret or select “Off” to leave it as it is.

To Make the Entry Completed or Uncompleted

“Organiser & Tools” → “Tasks”

1. Highlight the desired entry.
2. Press .
3. On the view screen, press [Options] and select “Check”.

To make the entry uncompleted, select “Uncheck”.

Sending a Task Entry

“Organiser & Tools” → “Tasks”

1. Highlight the task entry you wish to send.
2. Press [Options] and select “Send”.
3. Select “As Message”, “Via Bluetooth” or “Via Infrared”.

For details on creating a message, see “Creating a New Message” on page 50.

For details on *Bluetooth* wireless settings, see “Bluetooth” on page 111.

For details on Infrared settings, see “Infrared” on page 113.

Note

- *When pairing, you need to enter your passcode when establishing contact with a Bluetooth wireless technology enabled device for the first time.*

Viewing the Memory Status

“Organiser & Tools” → “Tasks”

1. Press [Options] and select “Memory Status”.

Deleting Entries

“Organiser & Tools” → “Tasks” → [Options] → “Delete”

1. Select the desired option.

“This Task”:	Deletes the selected entry.
“All Completed Tasks”:	Deletes all checked entries.
“All Tasks”:	Deletes all entries.



World Clock (M 7–9)

Setting the Time Zone

“Organiser & Tools” → *“World Clock”*

1. Press [Edit] and select “Set Time Zone”.

The current time zone is indicated by red line on the world map.

2. Press  or  to change the time zone.
3. Press .

To Set the Custom Time Zone

“Organiser & Tools” → *“World Clock”*

1. Press [Edit] and select “Set Time Zone”.
2. Press [Options] and select “Set Custom Zone”.
3. Enter the desired city name and time.

Setting the Daylight Saving

“Organiser & Tools” → *“World Clock”*

1. Press [Edit] and select “Daylight Saving”.
2. Select “On” or “Off”.

Countdown Timer (M 7–10)

“Organiser & Tools” → *“Countdown Timer”*

1. Enter the time to count.

You can set the time from 1 second to 60 minutes.

2. Press  to start counting.

3. Press  to pause.

Press  again to continue counting.

4. If the countdown has finished, press [Cancel] and then press  to start the countdown again.

Editing the Countdown Time

1. In the countdown start screen, press [Options] and select “Edit”.
2. Modify the desired time.

Expenses Memo (M 7–11)

You can record an expenses memo with predefined or edited categories.

Recording in the Expenses Memo (M 7–11–1)

“Organiser & Tools” → *“Expenses Memo”* → *“Add New Expense”*

1. Enter the expenses using the digit keys.
2. Select the desired category.
Expenses memo is registered.

Viewing Totals (M 7-11-2)

“Organiser & Tools” → “Expenses Memo” → “Totals”

Recorded expenses are displayed on the screen.

To Change Amount

1. In the total view, select the desired item.
2. Press [Options] and select “Change Amount”.
3. Enter the desired amount using the digit keys.

To Delete a Recorded Item or All Items

1. In the total view, select the desired item.
2. Press [Options] and select “Delete Item” or “Delete All”.

Editing the Category Name (M 7-11-3)

“Organiser & Tools” → “Expenses Memo” → “Edit Category”

1. Select the desired category name.
2. Modify the name.

Phone Help (M 7-12)

You can view the help list and use it to guide you in the phone's functions.

“Organiser & Tools” → “Phone Help”

1. Press  or .

SIM Application (M 11)

You can refer to the information on the SIM/USIM. Contact your service provider for further details.

Settings (M 12)

Profiles (M 12–1)

The ringtone, sound, vibration and light settings can be customised for each profile according to your environment.

There are 6 profiles: “Normal”, “Meeting”, “Activity”, “Car”, “Headset” and “Silent”.

Activating a Profile

“Settings” → “Profiles”

1. Select the desired profile.

Note

- When a profile is set, the corresponding indicator described on page 17 is displayed in standby.

Tip

- In standby, press and hold **[# *]** to switch Profiles between Silent mode and the profile most recently activated.

Resetting Profile Settings

“Settings” → “Profiles”









1. Highlight the profile you wish to reset.
2. Press [Options] and select “Set to Default”.
3. Enter your handset code.

The default handset code is “9999”. For details on changing the handset code, see “Changing the Handset Code” on page 108.

Volume

You can adjust the volume for incoming voice calls, SMS/MMS/Email messages and other sounds (“General Volume”) to one of six levels, or set an increasing volume for all of these except “General Volume”.

“Settings” → “Profiles”

1. Highlight the profile you wish to customise.
2. Press [Options] and select “Personalise”.
3. Select “Volume”.
4. Select “For Incoming Call”, “For New Message” or “General Volume”.
5. Press  (or ) to increase the ringer volume or press  (or ) to decrease the ringer volume and then press .
To select “Increasing Volume”, press  (or ) at level 5.
To select “Silent”, press  (or ) at level 1.

Tip

- You can select from two levels or an increasing volume, when selecting the “Silent” profile.

Assigning a Ringtone

You can select the ringtone from 28 tones including 5 patterns, 13 sound effects and 10 melodies. You can also select a sound in Saved Sounds as the default ringtone, excluding the AMR format.

“Settings” → “Profiles”

1. Highlight the profile you wish to customise.
2. Press [Options] and select “Personalise”.
3. Select “Ringtone/Ringvideos”.
4. Select “For Voice Call” or “For Video Call”.
5. Select “Assign Tone”.
6. Select “Preset Sounds” or “My Sounds”.
7. Highlight the ringtone you wish to use.
To hear the demo play, press [Options] and select “Play”.
8. Press [Options] and select “Assign” for “Preset Sounds” or “Select” for “My Sounds”.

Note

- *Even if you delete a ringtone that uses a sound in Sounds & Ringtones, the setting remains the same and the default ringtone sounds. If you delete a ringtone assigned for the ringtone, the default ringtone is set.*

Assigning a Ring Video Clip File

You can select a video clip file in Saved Videos as the default ring video clip file.

“Settings” → “Profiles”

1. Highlight the profile you wish to customise.
2. Press [Options] and select “Personalise”.
3. Select “Ringtone/Ringvideos”.
4. Select “For Voice Call” or “For Video Call”.
5. Select “Assign Video”.
6. Highlight the ring video clip file you wish to use.
To preview the file, press [Options] and select “Play”.
7. Press [Options] and select “Select”.

Message Notification

When receiving messages, your phone will notify you of their arrival with the ringtone or ring video you specify.

“Settings” → ***“Profiles”***

1. Highlight the profile you wish to customise.
2. Press [Options] and select “Personalise”.
3. Select “Ringtone/Ringvideos”.
4. Select “For New Message”.
5. Select “Assign Tone” or “Assign Video”.

If “Assign Tone” is selected, select “Preset Sounds” or “My Sounds”.

6. Highlight the desired ringtone or ring video clip.

For details on selecting a ringtone or a ring video, see “Assigning a Ringtone” or “Assigning a Ring Video Clip File” on page 94.

7. Press [Options] and select “Assign” for “Preset Sounds” or “Select”.
8. Select “For New Message” and select “Duration”.
9. Enter the desired duration.

Keypad Tones

When the keypad tone is set on, you will hear a confirmation tone each time you press any keys.

“Settings” → ***“Profiles”***

1. Highlight the profile you wish to customise.
2. Press [Options] and select “Personalise”.
3. Select “System Sounds”.
4. Select “Keypad Tones”.
5. Highlight the desired tone pattern.
6. Press [Options] and select “Assign”.

Warning Tone

Your phone emits a warning tone when an error occurs.

“Settings” → ***“Profiles”***

1. Highlight the profile you wish to customise.
2. Press [Options] and select “Personalise”.
3. Select “System Sounds”.
4. Select “Warning Tone”.
5. Select “Tone” or “Duration”.

For “Tone”, select “Off”, “Preset Sounds” or “My Sounds”.

For “Duration”, select the desired time between 0.5 and 2 seconds.

Power On/Off Sound

The phone can be set to emit a sound when it is switched on or off. You can set the duration and melody of the sound.

“Settings” → “Profiles”

1. Highlight the profile you wish to customise.
2. Press [Options] and select “Personalise”.
3. Select “System Sounds”.
4. Select “Power On Sound” or “Power Off Sound”.
5. Select “Sound” or “Duration”.
For “Sound”, select “Off”, “Preset Sounds” or “My Sounds”.

Vibration

“Settings” → “Profiles”

1. Highlight the profile you wish to customise.
2. Press [Options] and select “Personalise”.
3. Select “Vibration”.
4. Select “On”, “Link to Sound” or “Off”.

Tip

- When the “Link to Sound” option is selected in step 4, the vibrator pulses in time with the selected melody. Please note that not all melodies support the “Link to Sound” option.
- When you select “On” or “Link to Sound” in step 4, “” is displayed in standby.

Event Light

When the light option is on, the mobile light blinks while the phone receives a call or message.

“Settings” → “Profiles”

1. Highlight the profile you wish to customise.
2. Press [Options] and select “Personalise”.
3. Select “Event Light”.
4. Select “For Voice Call”, “For Video Call” or “For New Message”.
5. Select “Switch On/Off”.
6. Select “On” or “Off”.

To Change the Light Colour

You can select from 7 colours and 1 pattern for each profile.

1. In step 5 in “Event Light”, select “Light Colour”.
2. Select the desired colour.

Tip

- If you select “Disco” in step 2, all 7 colours flash in order.

Status Light

When the light option is on, the mobile light or small light blinks to let you know when you have missed calls or new messages.

“Settings” → “Profiles”



1. Highlight the profile you wish to customise.
2. Press [Options] and select “Personalise”.
3. Select “Status Light”.
4. Select “For Missed Call” or “For New Message”.
5. Select “Switch On/Off”.
6. Select “On(Mobile Light)”, “On(Small Light)” or “Off”.

To Change the Light Colour

You can select from 7 colours when “Status Light” is set to “On(Mobile Light)”.

1. In step 5 in “Status Light”, select “Mobile Light Colour”.
2. Select the desired colour.

Any Key Answer

You can answer a call by pressing any key except ,  and [Busy]. For details, see “Answering a Voice Call” on page 21.

“Settings” → “Profiles”

1. Highlight the profile you wish to customise.
2. Press [Options] and select “Personalise”.
3. Select “Any Key Answer”.
4. Select “On” or “Off”.

Setting the Display (M 12–2)

You can change the settings of the display.

Setting the Wallpaper (M 12–2–1)

For the standby screen, 5 pictures are provided. Pictures taken with the digital camera or images downloaded from a WAP site can be used for wallpapers.

To Set My Pictures

“Settings” → “Display Settings” → “Wallpaper”

1. Select “My Pictures”.
2. Select the desired picture.
3. After displaying the picture, press .

Note

- Some pictures cannot be used because of their picture and data types.
- If the picture in My Pictures is already set, it is displayed in step 1. Press [Change] and select the desired picture.

System Graphics (M 12–2–2)

Pictures can be displayed when turning the power on or off, when receiving an incoming call, or when operating the alarm.

Pictures taken with the digital camera or images downloaded from a WAP site can be used.

To Use Preset Animation/Pattern

“Settings” → **“Display Settings”** → **“System Graphics”**

1. Select the desired scene to set the picture to.
2. Select “Preset Animation” when you select “Power On” or “Power Off” in step 1.

Select “Pattern 1”, “Pattern 2” or “Pattern 3” when you select “Incoming Call” or “Alarm” in step 1.

To Set My Pictures

“Settings” → **“Display Settings”** → **“System Graphics”**

1. Select the desired scene to set the picture to.
2. Select “My Pictures”.
3. Select the desired picture.
4. After displaying the picture, press .
5. Specify the area you wish to display using the navigation keys.

Note

- *Some pictures cannot be used because of their picture and data types.*
- *If the picture in My Pictures is already set, it is displayed in step 2. Press [Change] and select the desired picture.*

Setting the Font Weight (M 12–2–3)

“Settings” → **“Display Settings”** → **“Font Settings”**

1. Select “Thin”, “Normal”, “Bold” or “Bolder”.

The preview image is displayed in the selected weight.

Setting the Greeting Message (M 12–2–4)

You can set the message which is displayed when the phone is turned on.

“Settings” → **“Display Settings”** → **“Greeting Message”** → **“Switch On/Off”**

1. Select “On” or “Off”.
2. Select “Edit Message” and enter the message (up to 10 characters).

Backlight (M 12–2–5)

The backlight will shut off if you do not press the keypad for a certain length of time. You can specify a desired time to elapse before the backlight shuts off, which will help conserve battery life.

Tip

- When you purchase this phone, Backlight is set to 15 seconds.

To Select the Backlight Time Out



“Settings” → **“Display Settings”** → **“Backlight”** → **“Time Out”**

1. Select the desired time.

Select “Off” to shut it off.

To Adjust the Brightness of the Backlight

“Settings” → **“Display Settings”** → **“Backlight”** → **“Brightness”**

1. Press  and  to switch between 4 levels of clarity.
2. Press .

Setting the Display Saving (M 12–2–6)

The screen of this phone will automatically turn off after a given amount of time. You can change the length of time before the Display Saving goes into effect, which will help conserve battery life.

“Settings” → **“Display Settings”** → **“Display Saving”**

1. Select the desired time.

When you purchase this phone, Display Saving is set to 2 minutes.

Note

- Display Saving does not work while you are making a call, using WAP, or using an application.
- To cancel the Display Saving: The display saving continues until either a key is pressed or there is an incoming alert. The first key press only cancels this function. You must press another key in order to enter any numerical or text value.

Setting Video Out (M 12–2–7)

With the optional cable, you can connect your phone to other device, such as TVs or videos set to output, and display images or video clips stored on your phone. It is also possible to output and display data stored in the memory card.

To Set Output Function On

You need to connect your phone to the other device with the optional cable beforehand.

“Settings” → **“Display Settings”** → **“Video Output”** → **“Switch On/Off”**

1. Select “On”.

Select “Off” on the Output screen when finished.

Note

- When closing your phone, you cannot output data to the connected device.
- It is not possible to output some images or video clips.

To Select Display Size

You can display images in enlarged size.

“Settings” → **“Display Settings”** → **“Video Output”** → **“Display Size”**

1. Select “Enlarge”.

To display in original size, select “Original Size”.

To Rotate Image

“Settings” → **“Display Settings”** → **“Video Output”** → **“Rotation Setting”**

1. Select the desired item.

The image displayed on the device will rotate until the selected degree.

To Select TV System

You need to select the appropriate TV system. Refer to the instruction manual of your connected device to confirm the TV system.

“Settings” → **“Display Settings”** → **“Video Output”** → **“TV System”**

1. Select the desired item.

Sound Settings (M 12–3)

You can use this menu to check or edit the current Profiles settings (except “Any Key Answer”).

Setting the Surround Sound

“Settings” → **“Sound Settings”** → **“Surround”**

1. Select “On”, “Link to Sound” or “Off”.



Date & Time (M 12–4)

You need to set the correct time and date in order for your phone's various time-based functions to work correctly.

“Settings” → **“Date & Time”** → **“Set Date/Time”**

1. Enter the day, month and year using the digit keys.
2. Enter the time using the digit keys.

Tip

- When you enter the time in the 12-hour format, press  or  to switch between am and pm. The order in which the date and time is displayed is based on the format setting.



Setting the Daylight Saving (M 12–4–2)

“Settings” → **“Date & Time”** → **“Daylight Saving”**

1. Select “On” or “Off”.



Setting the Time Zone (M 12–4–3)

“Settings” → **“Date & Time”** → **“Set Time Zone”**

1. Press  or  to select the home city to set.
2. Press .

Customising the Time Zone

“Settings” → **“Date & Time”** → **“Set Time Zone”** → **[Options]**
→ **“Set Custom Zone”**

1. Enter the city name.
2. Enter the time–zone differences using the digit keys.
Press  or  to switch between – and +.
3. Press .

Display Date & Time (M 12–4–4)

You can display the calendar or the current date and/or time in standby.

To Set the Clock Display

“Settings” → **“Date & Time”** → **“Display Date & Time”** → **“Show Clock”**

1. Select the desired clock type or “Off” to set clock display off.

To Set the Calendar Display

“Settings” → **“Date & Time”** → **“Display Date & Time”** → **“Show Calendar”**

1. Select the desired calendar type or “Off” to set calendar display off.

World Clock (M 12–4–5)

For details, see “World Clock” on page 90.

Selecting the Time Format (M 12–4–6)

“Settings” → **“Date & Time”** → **“Time Format”**

1. Select “24 Hour” or “12 Hour”.

Selecting the Date Format (M 12–4–7)

“Settings” → **“Date & Time”** → **“Date Format”**

1. Select “D.M.Y”, “M–D–Y” or “Y/M/D”.

Setting the Calendar Format (M 12–4–8)

“Settings” → **“Date & Time”** → **“Calendar Format”**

1. Select “Sunday–Saturday” or “Monday–Sunday”.

Language Setting (M 12–5)

You can change the language displayed on the phone.

“Settings” → **“Language”**

1. Select the desired language.

Note

- If you select “Automatic” in step 1, the language preset on the SIM/USIM card is selected.
- If the language preset on the SIM/USIM card is not supported, then the default language of the phone is selected.

Tip

- You can also change the input language on the text entry screen (p. 30).

Call Settings (M 12–6)

Voicemail & Diverts (M 12–6–1)

This service can be used to divert incoming calls that you cannot answer. Calls can be diverted to another phone number or to your voicemail system.

Note

- *This service may not be available on all mobile phone networks. Contact your service provider for more information.*

To Set the Voicemail Numbers

You can divert calls to the network voicemail service centre. Depending on whether you are inside or outside your network area, you can set two voicemail numbers, a number for your home network area or for a roaming network area.

Note

- *This service depends on the SIM card. Contact your SIM card vendor for more information.*

“Settings” → “Call Settings” → “Voicemail & Diverts” → “Voicemail” → “Settings” → “Voicemail Numbers”

1. Select “Home Mailbox” or “Roam Mailbox”.
2. Enter the desired phone number.

To Access the Voicemail Centre

1. Press and hold  in standby.

To Activate the Voicemail Service

“Settings” → “Call Settings” → “Voicemail & Diverts” → “Voicemail” → “Activate”

1. Select one of the following options:

- | | |
|------------------|---|
| “Always”: | Diverts all calls without ringing. |
| “When Busy”: | Diverts incoming calls while you are talking on the phone. |
| “No Answer”: | Diverts incoming calls if you do not answer a call within a certain period of time. |
| “Not Reachable”: | Diverts incoming calls when your phone has no network service or is switched off. |

If you select “No Answer”, select the period of time from 6 levels (05 to 30 seconds).

2. Press .

To Activate the Diverts Service

Select the appropriate option.

“Settings” → **“Call Settings”** → **“Voicemail & Diverts”** → **“Diverts”**

1. Select “Activate” or “By Service”.

If you select “By Service”, you can select further divert options.

2. Select “Always”, “When Busy”, “No Answer” or “Not Reachable”.

If you select “No Answer”, select the period of time from 6 levels (05 to 30 seconds).

3. Enter a phone number to which you wish to divert calls or search for it in the Contacts List (p. 35).

4. Press .

Note

- When “Voice Calls” diverts are set to “Always”, “” is displayed in standby.

To Check the Diverts Status

“Settings” → **“Call Settings”** → **“Voicemail & Diverts”** → **“Status”**

1. Select the diverts option you wish to check.

To Deactivate the Diverts/Voicemail Service

“Settings” → **“Call Settings”** → **“Voicemail & Diverts”** → **“Deactivate”**

1. Select the desired option.

To Cancel the Diverts and Voicemail Service

Once you have changed the diverts settings, you can cancel them all with this service.

“Settings” → **“Call Settings”** → **“Voicemail & Diverts”** → **“Cancel All”**

Call Waiting (M 12–6–2)

Note

- This service may not be available on all mobile phone networks. Contact your service provider for more information.

If you wish to be able to receive another incoming call while you have a call in progress, you must activate the Call Waiting service.

“Settings” → **“Call Settings”** → **“Call Waiting”**

1. Select “On”, “Off” or “Status”.

Showing Your Phone Number (M 12–6–3)

This lets you control whether to show your phone number when calling another party or not.

“Settings” → **“Call Settings”** → **“Show Your Number”**

1. Select “On”, “Off” or “Status”.

Note

- Some networks do not support this service. Please check with your service provider for availability.

Restrict Calls (M 12–6–4)

This function lets you place restrictions on incoming and outgoing calls. To activate this option you will need the specified password, which is available from your service provider.

“Settings” → “Call Settings” → “Restrict Calls”

1. Select “Outgoing Calls” or “Incoming Calls”.

“Outgoing Calls”: Restricts outgoing calls.

“Incoming Calls”: Restricts incoming calls.

2. Select one of the following options:

(For “Outgoing Calls”)

“Bar All Outgoing Calls”: Restricts all outgoing calls except emergency calls.

“Bar International Calls”: Restricts all outgoing international calls.

“Only Local & Home”: Restricts all outgoing international calls except to your home country.

(For “Incoming Calls”)

“Bar All Incoming Calls”: Restricts all incoming calls.

“Bar if Abroad”: Restricts all incoming calls when you are outside of the coverage from your registered service provider.

3. Select one of the following options:

“All Services”: Restricts all services.

“Voice Calls”: Restricts all voice calls.

“Video Calls”: Restricts all video calls.

“Fax”: Restricts all fax calls.

“Messages”: Restricts all messages.

4. Select “On”, “Off” or “Status”.

5. Enter the network password.

To Cancel Settings

“Settings” → “Call Settings” → “Restrict Calls”

1. Select “Outgoing Calls” or “Incoming Calls”.

2. Select “Cancel All”.

3. Enter the network password.

Rejecting an Incoming Call

You can register phone numbers you do not wish to answer.

To Reject the Registered Number

“Settings” → “Call Settings” → “Restrict Calls” → “Rejected Numbers” → “Switch On/Off”

1. Select “On” or “Off”.

To Register the Rejected Number

“Settings” → “Call Settings” → “Restrict Calls” → “Rejected Numbers” → “Set Rejecting Number”

1. Select a blank field.

2. Enter the desired number.

Withheld Call

When the “Withheld Call” is set, incoming calls without a CLI (Calling Line Identification) are rejected.

“Settings” → **“Call Settings”** → **“Restrict Calls”** → **“Withheld Call”**

1. Select “On” or “Off”.

Changing the Network Password

“Settings” → **“Call Settings”** → **“Restrict Calls”** → **“Change N/W Password”**

1. Enter the old network password.
2. Enter a new network password.
3. Enter the new network password again.

If you enter the incorrect password, you are asked to enter the password again.

4. Press .

Fixed Dialling Number

When the Fixed Dialling Number is enabled, you can only call pre-registered numbers.

To Enable Fixed Dialling Number

“Settings” → **“Call Settings”** → **“Restrict Calls”** → **“Fixed Dialling Number”** → **“Switch On/Off”**

1. Select “On” to enable this function.

To Add a New Name

“Settings” → **“Call Settings”** → **“Restrict Calls”** → **“Fixed Dialling Number”** → **“Edit Dial List”**

1. Highlight the blank entry, press [Options], then select “Add New Dial”.
2. Enter your PIN2 code.
3. Add a name and a phone number.

For details on adding a name and a phone number, see “Add New Contact” on page 35.

4. Press [Save].

Minute Minder (M 12–6–5)

Minute Minder function informs you of your talk time by sounding a tone after every minute.

“Settings” → **“Call Settings”** → **“Minute Minder”**

1. Select “On” or “Off”.

Displaying Call Time Counter (M 12–6–6)

“Settings” → **“Call Settings”** → **“Call Time Counter”**

1. Select “On” or “Off”.

Displaying Call Costs (M 12–6–7)

“Settings” → **“Call Settings”** → **“Display Call Cost”**

1. Select “On” or “Off”.

Auto Redial (M 12–6–8)

“Settings” → **“Call Settings”** → **“Auto Redial”**

1. Select “On” or “Off”.

Video Call Settings (M 12–7)

Set various types of functions and services for video calls.

Selecting the Camera Picture (M 12–7–1)

You can select an image shown to the caller between the sub camera image and an alternative image.

“Settings” → **“Video Call Settings”** → **“Camera Picture”**

1. Select “Default Image”.
2. Select “Internal Camera” or “Alternative Image”.

To Select the Picture for the Alternative Image

This function is available only when “Alternative Image” is selected for “Default Image”.

“Settings” → **“Video Call Settings”** → **“Camera Picture”**

1. Select “Alternative Image”.
2. Select “Preset Picture” or “My Pictures”.
3. Select the desired picture.

Turning On or Off the Speakers (M 12–7–2)

“Settings” → **“Video Call Settings”** → **“Loudspeaker”**

1. Select “On” to turn on the loudspeakers on the sides of your phone, or select “Off” to turn it off.

Selecting the Picture Quality (M 12–7–3) (M 12–7–4)

Select the desired data format for your environment.

“Settings” → **“Video Call Settings”** → **“Incoming Picture Quality”**

“Settings” → **“Video Call Settings”** → **“Outgoing Picture Quality”**

1. Select “Normal”, “Quality Priority” or “Frame Rate Priority”.
Select “Frame Rate Priority” to perform faster communication.

Backlight (M 12–7–5)

With this setting On, the phone’s backlight is on when making a video call.

“Settings” → **“Video Call Settings”** → **“Backlight”**

1. Select “Always On”, “Always Off” or “As Normal Setting”.
The “As Normal Setting” option depends on the backlight setting of the main display (p. 99).

Mute (M 12–7–6)

You can mute the microphone while making a video call.

“Settings” → **“Video Call Settings”** → **“Mute Microphone”**

1. Select “On” to mute or “Off” to cancel mute.

Assigning Hold Guidance Picture (M 12–7–7)

You can display an image saved in the phone on your main display while you are putting a call on hold.

“Settings” → “Video Call Settings” → “Hold Guidance Picture”

1. Select “Preset Picture” or “My Pictures”.
2. Select the desired picture.

Security (M 12–8)

Enabling/Disabling the PIN Code (M 12–8–1)

If the PIN code is enabled you are asked to enter the PIN code each time the phone is switched on. Your PIN code is registered on the SIM/USIM card and you should have been made aware of the code when you purchased the SIM/USIM card. Contact your service provider for further details.

“Settings” → “Security” → “PIN Entry” → “Switch On/Off”

1. Select “On” to enable the PIN code or “Off” to disable.
2. Enter your PIN code.

Note

- If you enter the wrong PIN code three times in step 2, the SIM/USIM card will lock. To remove the lock, contact your service provider/SIM/USIM card vendor.

To Change the PIN Code

This allows you to change the PIN code registered on the SIM/USIM card. Before you change the PIN code, select “On” in step 1 in “Enabling/Disabling the PIN Code”.

“Settings” → “Security” → “PIN Entry” → “Change PIN”

1. Enter the existing PIN code.
2. Enter a new PIN code.
3. Enter the new PIN code again.

Changing the PIN2 Code (M 12–8–2)

The PIN2 code is used to protect certain functions in the phone such as Fixed Dialling Number and call cost limits. The following shows you how to change the PIN2 code.

“Settings” → “Security” → “Change PIN2”

1. Enter the existing PIN2 code.
2. Enter a new PIN2 code.
3. Enter the new PIN2 code again.

Handset Lock (M 12–8–3)

The Handset Lock is an additional security feature which prevents unauthorised use of the phone or certain features.

“Settings” → “Security” → “Handset Lock”

1. Select “On” or “Off”.
2. Enter your handset code.

Function Lock (M 12–8–4)

By setting this option on, all the functions of your phone will be locked until the correct handset code is entered.

“Settings” → “Security” → “Function Lock”

1. Enter your handset code.

The default handset code is “9999”. For details on changing the handset code, see “Changing the Handset Code”.

To Turn Off the Function Lock

Enter your handset code in standby to turn the Function Lock off.

Contacts Lock (M 12–8–5)

The Contacts Lock function prevents unauthorised use of your Contacts List.

“Settings” → “Security” → “Contacts Lock”

1. Select “On” to lock or “Off” to unlock.
2. Enter your handset code.

Showing Secret Data (M 12–8–6)

By setting this option on, the hidden data can be displayed.

“Settings” → “Security” → “Show Secret Data”

1. Select “On” to display or “Off” to hide.
2. Enter your handset code when you select “On”.

Changing the Handset Code (M 12–8–7)

The default handset code is “9999”.

“Settings” → “Security” → “Change Handset Code”

1. Enter the old handset code.
2. Enter a new handset code.
3. Enter the new handset code again.

Master Reset (M 12–9)

Resetting Settings from M1 to M12 (M 12–9–1)

“Settings” → “Master Reset” → “Reset Settings”

1. Enter your handset code.

The default handset code is “9999”. For details on changing the handset code, see “Changing the Handset Code”.

Note

- All settings are not reset.

Resetting All Settings from M1 to M12 and All Created Data (M 12–9–2)

“Settings” → “Master Reset” → “Reset All”

1. Enter your handset code.

For details on the handset code, see “Changing the Handset Code”.

Call Log (M 9)



The phone will record the last 30 missed calls, received calls and dialled numbers.

Viewing Call Log

“Call Log”

1. Select “All Calls”, “Dialled Numbers”, “Missed Calls” or “Received Calls”.

The selected call log list is displayed.

To switch logs, press  or .

2. Select the phone number you wish to view.

If you wish to dial the number, press .

Tip

- You can also confirm call logs by pressing  in standby.

Sending Messages

1. In the call log list, highlight the phone number or name you wish to send a message to.
2. Press [Options] and select “Create Message”.

For details on creating a message, see “Creating a New Message” on page 50.

Note

- The Postcard service is not available with some service providers. Please contact your service provider for more information.

Deleting a Call Log

1. In the call log list, press [Options] and select “Delete” or “Delete All”.

Call Timers (M 9–5)

This function lets you check the duration of your calls.

Checking the Duration of the Last Call and All Calls

“Call Log” → “Call Timers”

1. Select “Received Calls” or “Dialled Calls”.

Resetting Call Timers (M 9–5–3)

“Call Log” → “Call Timers” → “Clear Timers”

1. Enter your handset code.

The default handset code is “9999”. For details on changing the handset code, see “Changing the Handset Code” on page 108.

Data Counter (M 9–6)

You can confirm the number of bytes used in the 3G (UMTS) and GSM transmission.

“Call Log” → “Data Counter”

1. Select “Last Data” or “All Data”.

Resetting All Data Counter (M 9–6–3)

“Call Log” → “Data Counter” → “Clear Counter”

Call Costs (M 9-7)

This function lets you check the charges for your calls. Some networks do not support Charging Advice. Please check with your service provider for availability.

Checking the Cost of the Last Call (M 9-7-1)

“Call Log” → “Call Costs” → “Last Call”

Checking the Total Call Cost (M 9-7-2)

“Call Log” → “Call Costs” → “All Calls”

Setting the Charge Rate (M 9-7-5)

Set the charge rate to calculate the call cost and set the maximum limit for call cost.

“Call Log” → “Call Costs” → “Cost Units” → “Set Units”

1. Enter your PIN2 code.
2. Enter a currency unit (up to 3 characters).
3. Enter a cost per unit.

To enter a decimal point, press .

Setting the Charge Limit (M 9-7-6)

This function is useful if you wish to make sure you do not exceed a certain charge limit.

“Call Log” → “Call Costs” → “Max Cost” → “Set Limit”

1. Enter your PIN2 code.
2. Enter a value.

Checking the Residual Credit (M 9-7-3)

“Call Log” → “Call Costs” → “Residual Credit”

Resetting All Call Costs (M 9-7-4)

“Call Log” → “Call Costs” → “Clear Costs”

1. Enter your PIN2 code.

Connectivity (M 10)

By configuring the settings in this menu, you can connect to *Bluetooth* wireless technology or Infrared enabled phones via these connections, as well as a PC via *Bluetooth* wireless technology or Infrared connections.

Bluetooth (M 10–1)

For using the *Bluetooth* wireless function, you need to search for other *Bluetooth* wireless technology enabled devices to establish contact with your phone. Keep your phone within a distance of 10 metres from the devices before searching.

Using the Bluetooth Wireless Function

To Turn On or Off (M 10–1–1)

“Connectivity” → **“Bluetooth”** → **“Switch On/Off”**

1. Select “On” or “Off”.

The *Bluetooth* wireless setting is activated, “On” is selected and “” is displayed.

To Show or Hide Your Phone (M 10–1–2)

“Connectivity” → **“Bluetooth”** → **“Visibility”**

1. Select the desired visibility settings.

“Show My Phone”: Allows other devices to recognise your phone.

“Hide My Phone”: Hides your phone from other devices.

To Search for Devices to be Paired (M 10–1–3)

A maximum of 16 devices can be searched for.

“Connectivity” → **“Bluetooth”** → **“Search for Devices”**

1. Select the desired device for pairing.
2. Enter the device passcode.

Note

- If the *Bluetooth* wireless function is off before searching, the phone turns the *Bluetooth* wireless function on automatically and starts searching.
- You can only select one device for pairing. To change the paired device, see “To Activate the Paired Device” on page 112.

Tip

- You can save battery power by turning the *Bluetooth* wireless function off while it is not in use. Turn the *Bluetooth* wireless function off in “To Turn On or Off” on this page or in “To Turn Off Automatically” on page 113.
- During a call, you can divert voice calls to the paired handsfree device. Press [Options], select “Transfer Audio” and then “To *Bluetooth*” or “To Handset”.

To Activate the Paired Device (M 10–1–4)

Paired devices are listed by tabs for all devices and for handsfree devices.

“Connectivity” → “Bluetooth” → “Paired Devices”

1. Press  to switch to the list for handsfree devices.
2. Select the desired device you wish to activate.



To Check and Uncheck the Paired Handsfree Devices

“Connectivity” → “Bluetooth” → “Paired Devices”

1. Select handsfree device list.
2. Press [Options] and select “Check” or “Uncheck”.

To Rename or Delete the Paired Devices

“Connectivity” → “Bluetooth” → “Paired Devices”

1. Press  or  to switch between all devices and handsfree devices.
2. Highlight the desired device.
3. Press [Options] and select “Change Name” or “Delete”.

To Send All Data to Other Devices (M 10–1–5)

You can send all the data for applications such as Contacts List, Calendar, Tasks, etc. to selected devices.

“Connectivity” → “Bluetooth” → “Send All”

1. Select the desired device.

If a device is not specified, searching starts automatically.

2. Enter your handset code.

The default handset code is “9999”. For details on changing the handset code, see “Changing the Handset Code” on page 108.

3. Select the desired data to send.
4. Enter the device passcode for unpaired devices.

Note

- *If the handsfree device is connected, the confirmation screen to deactivate the handsfree function is displayed. Press [Yes] to deactivate.*

Bluetooth Wireless Settings (M 10–1–6)

With this setting you can rename your phone, prevent other phones from recognising your phone, turn the *Bluetooth* wireless function off automatically to save battery power, etc.

To Rename Your Phone

You can rename your phone. The name is shown in other devices when your phone is detected.

“Connectivity” → “Bluetooth” → “Bluetooth Settings” → “Device Name”

1. Enter the new device name.

To Turn Off Automatically

“Connectivity” → **“Bluetooth”** → **“Bluetooth Settings”** → **“Bluetooth Timeout”**

1. Select the desired time.

Your phone turns the function off automatically after the specified time.

To Switch the Handsfree Settings

You can switch modes of the handsfree kit between two modes; talking with the handsfree kit or talking with the phone.

“Connectivity” → **“Bluetooth”** → **“Bluetooth Settings”** → **“Handsfree Setting”**

1. Select “Private mode” or “Handsfree mode”.

“Private mode”: For talking with the phone

“Handsfree mode”: For talking with the handsfree kit

To Turn the Authentication Request On or Off

You can request the sender or receiver of the OBEX data to authenticate the passcode (exchanging the passcode) before pairing devices.

“Connectivity” → **“Bluetooth”** → **“Bluetooth Settings”** → **“Authentication”**

1. Select “On” or “Off”.

Note

- No authentication is required for the paired devices.
- Even if you select “Off”, you may authenticate the passcode when the sender requests it.

To See Your Phone Details

“Connectivity” → **“Bluetooth”** → **“Bluetooth Settings”** → **“My Phone Details”**

Infrared (M 10–2)

In order to use the infrared function, you need to search for other infrared enabled devices to establish contact with your phone. Keep your phone within a distance of 20 centimetres from the other phone before searching. The infrared setting will return to off when no data is transmitted/received via infrared communication.

Turning On or Off (M 10–2–1)

“Connectivity” → **“Infrared”** → **“Switch On/Off”**

1. Select “On” or “Off”.

The infrared setting is activated, and “

Sending All Data to Other Devices (M 10–2–2)

“Connectivity” → **“Infrared”** → **“Send All”**

1. Enter your handset code.

The default handset code is “9999”. For details on changing the handset code, see “Changing the Handset Code” on page 108.

2. Select the desired data to send.
3. Enter the authorisation code.

Network Settings (M 10–3)

Selecting a Service Automatically

Each time the power is turned on, your phone selects a service automatically.

“Connectivity” → **“Network Settings”** → **“Select Service”**

1. Select “Auto”.

Selecting a Service Manually

“Connectivity” → **“Network Settings”** → **“Select Service”**

1. Select “GSM”.

Selecting a Network Automatically

Each time the power is turned on, your phone always tries to connect to the preferred network.

If your phone is not connected to the network, you can perform the following immediately to establish the preferred network connection.

“Connectivity” → **“Network Settings”** → **“Select Network”**
→ **“Automatic”**

Setting the Network Manually

“Connectivity” → **“Network Settings”** → **“Select Network”**
→ **“Manual”**

1. Select the desired network.

Adding a New Network

“Connectivity” → **“Network Settings”** → **“Select Network”**
→ **“Add New Network”**

If there are no entries, press  and go to step 2.

If there is an entry, press  and perform the following steps.

1. Select “Add”.
2. Enter the country code (up to 3 digits).

3. Enter the network code (up to 3 digits).
4. Enter a new network name (up to 25 characters).
5. Select “Select network type”.
6. Select the desired network.

Editing the Preferred List

“Connectivity” → **“Network Settings”** → **“Select Network”**
→ **“Set Preferred”**

1. Select the name of the network you wish to edit.
2. Select “Insert” to insert over the selected position, “Add to end” to insert at the end or “Delete” to delete.

Showing the Network Information (M 10–3–3)

“Connectivity” → **“Network Settings”** → **“Network Information”**

Information about the operator name, package and services are displayed.

Flight Mode (M 10–4)

When the Flight Mode is set to “On”, the phone cuts off the network connections and stops searching for available networks to connect. With this mode, you can play games or music even when you fly.

“Connectivity” → “Flight Mode”

1. Select “On” or “Off”.

Internet Settings (M 10–5)

Note

- In normal operations, you do not need to change the settings.
- Internet settings have already been entered in your phone depending on your service provider. You may have restrictions on viewing, deleting, copying or modifying the settings. Contact your service provider for details.

WAP Settings (M 10–5–1)

“Connectivity” → “Internet Settings” → “WAP Settings” → “Create New”

“Profile Name”:	WAP profile name (Unique name)
“Proxy”:	Proxy setting for WAP (When “Use Proxy” is On)
“Access Point”:	Access point for WAP (When “Use Proxy” is Off)
“Use Proxy”:	Setting to connect by Proxy or not
“Home”:	Home page URL (When “Use Proxy” is Off)

Streaming Settings (M 10–5–2)

“Connectivity” → “Internet Settings” → “Streaming Settings” → “Create New”

“Profile Name”:	Profile name for streaming (Unique name)
“Proxy Address”:	Proxy address
“Proxy Port Number”:	Port number (1-65535)
“Access Point”:	Access point

Proxy Settings (M 10–5–3)

“Connectivity” → “Internet Settings” → “Proxy Settings” → “Create New”

“Proxy Name”:	Proxy name (Unique name)
“Proxy Address”:	IP address
“Access Point”:	Access point
“Home”:	Home page URL
“Port Number”:	Port number (1-65535)
“Authentication Type”:	Authentication Type (“HTTP-BASIC” or “HTTP-DIGEST”)
“User Name”:	User name for authentication
“Password”:	Password for authentication

Access Point Settings (M 10–5–4)

“Connectivity” → **“Internet Settings”** → **“Access Point Settings”** → **“Create New”**

“Access Point Name”:	Access point name (Unique name)
“APN”:	APN setting
“Authentication Type”:	Authentication type (“NONE”, “PAP” or “CHAP”)
“User Name”:	User name for access point
“Password”:	Password for access point
“DNS”:	DNS (Domain Name System)
“Linger Time”:	Linger Time (1-99999 sec.)

Re-Provisioning Settings (M 10–5–5)

“Connectivity” → **“Internet Settings”** → **“Re-Provisioning Settings”** → **“Execute Pending”**

Clearing DNS Cache (M 10–5–6)

“Connectivity” → **“Internet Settings”** → **“Clear DNS Cache”**

White List (M 10–5–7)

“Connectivity” → **“Internet Settings”** → **“White List”** → **“Create New”**

“SMSC Address”:	SMSC address
“SM Orig. Address”:	SM originating address

To Activate the WAP/Streaming Profile

“Connectivity” → **“Internet Settings”**

1. Select “WAP Settings” or “Streaming Settings”.
2. Select the desired profile you wish to activate.

To Edit/Copy/Delete the WAP/Streaming Profile

“Connectivity” → **“Internet Settings”**

1. Select “WAP Settings” or “Streaming Settings”.
2. Highlight the desired profile.
3. Press [Options] and select the desired option.

“Edit”:	Modify the desired item.
“Copy”:	Enter the new file name.
“Delete”:	Press [Yes] to delete.

Memory Card (M 10–6)

With a memory card inserted in your phone, you can make backup files of Bookmarks, Text, Contacts, Calendar and Tasks in the handset memory card to the memory card. You can also restore the backup data from the memory card.

Making a Backup File on the Memory Card

“Connectivity” → **“Memory Card”** → **“Backup/Restore”** → **“Backup”**

1. Enter your handset code.

The default handset code is “9999”. For details on changing the handset code, see “Changing the Handset Code” on page 108.

2. Select the desired item to backup or “Select All” to backup all files.

Restoring a Backup File

“Connectivity” → **“Memory Card”** → **“Backup/Restore”** → **“Restore”**

1. Enter your handset code.
2. Select the desired item to restore or “Select All” to restore all files.
3. Select the desired file to restore.

A confirmation message indicating deletion from the handset memory is displayed.

4. Press [Yes].

Note

- To delete a backup file, highlight the desired item, press [Options] and select “Delete” after performing steps 1 to 3.

Formatting Memory Card (M 10–6–2)

“Connectivity” → **“Memory Card”** → **“Format Card”**

1. Enter your handset code.

The default handset code is “9999”. For details on changing the handset code, see “Changing the Handset Code” on page 108.

2. Press [Yes] to start formatting.

Connecting 903SH to Your PC

You can use the following functions by connecting the 903SH to your PC using an Infrared port, a USB port* or *Bluetooth* wireless technology port:

- 3G/GSM modem
 - Handset Manager for 903SH
- * Requires an optional USB data cable XN-1DC30 for USB port connection.

System Requirements

Operating System:

Windows® 98*, Windows® Me, Windows® 2000**,
Windows® XP***

- * Windows® 98 Second Edition
- ** Service Pack 4 or later
- *** Service Pack 2 or later

Supported Software:

Microsoft® Outlook/Outlook Express

Interface:

Infrared port, USB port or *Bluetooth* wireless port

CD-ROM drive

3G/GSM Modem

You can use 903SH as a 3G/GSM modem to access the Internet from your PC. Connect your phone to your PC via *Bluetooth* wireless technology or USB interface. Software installation on your PC is required. For details, see “Software Installation” on page 119.

Modem via the USB Cable

To use the modem function using a USB cable, use the cable mentioned above and see the instructions accompanying the cable.

Modem via Bluetooth connection

To use the modem function via *Bluetooth* wireless technology interface, see “Using the Bluetooth Wireless Function” on page 111 and turn the modem function on.

For details on software support, refer to the following site:

<http://www.sharp-mobile.com>

Note

- *Modem communication is not possible while communicating with the Handset Manager via Bluetooth wireless technology, Infrared or USB interface.*
- *Your phone exhausts the battery when connected to a PC, even when not communicating.*

Handset Manager

You can transmit the following items between your phone and your PC, and can use Contacts List entries on your PC:

- My Items files (pictures/sounds/video clips/Other Documents data)
- Contacts List entries
- Schedule entries

For details on software support, refer to the following site:

<http://www.sharp-mobile.com>

Software Installation

1. Insert the supplied CD-ROM into your CD-ROM drive.
The 903SH CD-ROM screen is displayed.
If the 903SH CD-ROM screen is not displayed, double-click [Launcher.exe] in your CD-ROM.
2. Press the desired button.
3. Follow the on-screen instructions to complete installation.

Note

- *The phone may not recognise the USB data cable if it is connected while an application (Camera, My Items, etc.) is running. Connect the USB data cable in standby.*

Infrared Communication

- *Infrared ports need to be aligned with each other.*
- *Infrared ports need to be placed within 20 cm of each other and within a 30° angle.*

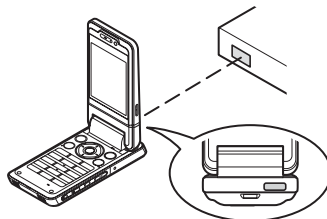

3G/GSM modem

- *It is not recommended that you make or answer calls when you are using 903SH as a 3G/GSM modem. The operation may be interrupted.*

Handset Manager

- *Some large files may not be able to be transmitted from the PC to the phone.*
- *Applications (Camera, My Items, etc.) do not run when the phone is connected to the PC via Bluetooth wireless technology interface, Infrared or USB data cable.*

Troubleshooting

Problem	Solution
The phone does not turn on.	<ul style="list-style-type: none"> • Make sure the battery is properly inserted and charged.
PIN code or PIN2 code is rejected.	<ul style="list-style-type: none"> • Make sure you have entered the correct code (4 to 8 digits). • Your SIM/USIM card/protected functions will become locked after three unsuccessful attempts. • Contact your SIM/USIM provider if you do not have the correct PIN code.
The SIM/USIM card becomes locked.	<ul style="list-style-type: none"> • Enter the PUK code (8 digits) provided by your service provider (if supported). • If the attempt is successful, enter the new PIN code and confirm your phone is operational again. Otherwise contact your dealer.
The display is difficult to read.	<ul style="list-style-type: none"> • Adjust the backlight brightness for the display.
Phone functions do not work after the phone is turned on.	<ul style="list-style-type: none"> • Check the radio signal strength indicator as you may be outside the service area. • Check to see if any error message is displayed when you turn your phone on. If so, contact your dealer. • Make sure the SIM/USIM card is correctly inserted.

Problem	Solution
Calls cannot be made or received.	<ul style="list-style-type: none"> • If the message “Insert SIM Card” is displayed when the phone is switched on, you cannot use your SIM/USIM card or the SIM/USIM card is damaged. Contact your dealer or network service provider. • Check your call barring, fixed dialling setting, remaining battery and call forwarding settings. • Check if your phone is currently performing data communication using Infrared (IrDA), <i>Bluetooth</i> wireless technology interface or a USB data cable. • Check the remaining balance if you are using a pre-paid SIM/USIM card.
Call quality is poor.	<ul style="list-style-type: none"> • Your current location may not provide good call quality (i.e., in a car or train). Move to a location where radio signal strength is greater.

Problem	Solution
Cannot access network service.	<ul style="list-style-type: none"> • Check where your account has been registered and where the service is available.
Cannot send or receive text message.	<ul style="list-style-type: none"> • Make sure you are correctly subscribed for the Short Message Service, that the network supports this service, and that the centre number is set up correctly. If not, contact your network service provider.
Cannot connect to Multimedia Messaging Service provider.	<ul style="list-style-type: none"> • MMS settings and configuration may be missing or incorrect or the network does not support it. Check your service provider's access point number. Contact your service provider to confirm the correct settings.
Limited memory available.	<ul style="list-style-type: none"> • Delete any unnecessary data.
Call is terminated unexpectedly.	<ul style="list-style-type: none"> • Magnetised objects such as health necklaces placed near the phone may terminate the call. Keep your phone away from such objects.
No entries are displayed in the Contacts List.	<ul style="list-style-type: none"> • Confirm that the Contacts Location setting (Handset or SIM/USIM) is correct.

Problem	Solution
Fax transmission failure.	<ul style="list-style-type: none"> • Before transmitting fax data, configure your fax software to use the software flow control. • Use of the optional data cable is recommended for transmitting fax data.
Cannot receive OBEX data.	<ul style="list-style-type: none"> • The OBEX data can only be received only in standby.

Safety Precautions and Conditions of Use

Your phone conforms to international regulations insofar as it is used under normal conditions and in accordance with the following instructions.

CONDITIONS OF USE

Electromagnetic waves

- Do not switch on your phone aboard an aircraft (as your phone may interfere with the aircraft's electronic systems). Current legislation forbids this use and legal action can be taken against the user.
- Do not switch on your phone in a hospital, except in designated areas.
- For body worn operation, this phone has been tested and meets RF exposure guidelines when used with an accessory that contains no metal and that positions the handset a minimum of 15 mm from the body. Use of other accessories may not ensure compliance with RF exposure guidelines.
- Use of your phone's function may affect the performance of medical electronic units (pacemakers, hearing aids, insulin pumps, etc.). When the phone function is on, do not bring it near medical equipment or into areas in which medical equipment is being used. If you have a hearing aid or a pacemaker, only use the phone on the opposite side of your body from where it is located. The phone should be kept at least 6 inches (15.24 cm) from a pacemaker ANYTIME the phone is switched on.
- Do not switch on your phone near gas or flammable substances.

- Observe the rules concerning the use of mobile phones at gasoline stations, chemical plants and at all sites where a risk of explosion exists.

Caring for your phone

- Do not allow children to use your phone without supervision.
- Do not open or attempt to repair your phone yourself. The product can only be repaired by authorised service personnel.
- Do not drop your phone or subject it to severe impacts. Bending the body and pushing the display or keys with extreme force could damage the phone.
- Do not use solvents to clean your phone. Use only a soft, dry cloth.
- Do not carry your phone in your back pocket as it could break when you sit down. The display is made of glass and is particularly fragile.
- Avoid touching the external connector on the underside of the phone, since the delicate components within can be damaged by static electricity.

Battery

- Use your phone only with batteries, chargers and accessories recommended by the manufacturer. The manufacturer disclaims any liability for damage caused by the use of other chargers, batteries or accessories.

- **Network configuration and phone usage will affect talk–time and standby time.**

Using the games or camera will hasten battery consumption.

- **When the battery charging alert is displayed on the screen, charge the battery as soon as possible.** If you continue using your phone ignoring the alert, the phone may cease to function, and all data and settings you have stored may be lost at any moment.
- Before removing the battery from the phone, make sure the phone is switched off.
- Replace and charge the new battery as soon as possible after removing the old one.
- Do not touch the battery terminals. Batteries can cause damage, injury or burns if a conductive material touches exposed terminals. When the battery is detached from the phone, use a cover made of non-conductive material for keeping and carrying the battery safely.
- Recommended temperature for using and storing batteries is approximately 20°C.
- The batteries' performance is limited in low temperatures, particularly below 0°C and the phone may not work temporarily regardless of the amount of remaining battery power.
- Exposing the phone to extreme temperatures will shorten battery life.
- The battery can be charged and discharged hundreds of times but it will eventually wear out. When the operating time (talk-time and standby time) is noticeably shorter than normal, it is time to buy a new battery.

CAUTION

RISK OF EXPLOSION IF BATTERY IS REPLACED
BY AN INCORRECT TYPE,
DISPOSE OF USED BATTERIES ACCORDING
TO THE INSTRUCTIONS

See "Battery Disposal" on page 12.

Memory Card

- Do not remove or insert a memory card while data on the card is being edited. Do not turn off the phone or device containing the memory card while data on the card is being edited as this may damage the data or cause the card to stop functioning correctly.
- Data may be lost under the following circumstances.
 - If the phone is dropped, or shook, or force is applied while the memory card is inserted.
 - When the phone is used in areas that are exposed to static electricity or electric noise.
- Backup your important data in case data on the memory cards are lost due to malfunctions.
- Do not touch the metal terminals with your hands or metal objects.

- Do not bend the memory card or subject it to violent impact. Keep it away from water and high temperatures.
- SHARP holds no responsibility for the loss or damage of data contained on a memory card.
- Keep all memory cards out of the reach of small children.

Aerial Care

- Do not cover the top of the phone (p. 8, No. 21) with your hand when in use as this may interfere with the performance of the built-in aerial. Call quality may deteriorate leading to shortened talk-time and standby time because the mobile phone has to operate on a higher power level than is necessary.
- Use only the aerial supplied or one approved by Sharp for your mobile phone. Using unauthorised or modified aerials may damage the mobile phone. Moreover, since the mobile phone may violate the appropriate regulations, it may lose performance or exceed the limitation of SAR levels.
- To avoid impaired performance, do not damage the aerial of the mobile phone.
- While talking directly to the microphone, please hold the mobile phone so that the aerial is upwards over your shoulder.
- To avoid interfering with blasting operations, please turn off the mobile phone in a blasting area or in a place where a "turn off two-way radio" sign is posted.

Camera Operation

- Learn picture quality, file formats, etc. beforehand.
The taken pictures can be saved in JPEG format.
- Be careful not to move your hand while taking pictures.
If the phone moves while taking a picture, the picture can become blurred. When taking a picture, hold the phone firmly to prevent it from moving, or use the delay timer.
- Clean the lens cover before taking a picture.
Fingerprints, oils, etc. on the lens cover hinder clear focusing.
Wipe them off with a soft cloth before taking a picture.

Others

- As with any electronic storage unit, data may be lost or corrupted under various circumstances.
- Before connecting the phone with a PC or a peripheral unit, read the operation manual for the other unit carefully.
- If the phone's battery has been removed for some time, or the phone has been reset, the unit's clock and calendar may be reinitialised. The date and time should be updated in this case.
- The phone uses a magnet to recognise that the phone is closed. Do not place magnetic cards near your phone or get the card caught in the phone as it may damage the recorded data.

ENVIRONMENT

- Keep your phone away from extreme heat. Do not leave it on the dashboard of a car or near a heater. Do not leave it in any place that is extremely damp or dusty.
- Since this product is not waterproof, do not use it or store it where fluids such as water can splash onto it. Raindrops, water spray, juice, coffee, steam, perspiration, etc. will also cause malfunctions.

PRECAUTIONS CONCERNING VEHICLE USE

- It is the user's responsibility to check the local laws governing the use of a mobile phone in vehicles. Pay full attention to driving. Pull off to the side of the road, park the car, and switch off the engine before making or answering a call.
- Use of your phone's function may interfere with the vehicle's electronic systems, such as the ABS anti-lock brakes or the air-bag. To ensure no such problem occurs, please check with your dealer or car manufacturer before connecting your phone.
- Only allow qualified service maintenance personnel to install the vehicle accessories.

The manufacturer disclaims any liability for damage which may result as a consequence of improper use or use contrary to the instructions contained herein.

SAR

Your mobile device is a radio transmitter and receiver. It is designed not to exceed the limits for exposure to radio waves recommended by international guidelines. These guidelines were developed by the independent scientific organization ICNIRP and include safety margins designed to assure the protection of all persons, regardless of age and health.

The guidelines use a unit of measurement known as the Specific Absorption Rate, or SAR. The SAR limit for mobile devices is 2 W/kg and the highest SAR value for this device when tested at the ear was 0.544 W/kg*. As mobile devices offer a range of functions, they can be used in other positions, such as on the body as described in this user guide**. In this case, the highest tested SAR value is 0.876 W/kg.

As SAR is measured utilizing the devices highest transmitting power the actual SAR of this device while operating is typically below that indicated above. This is due to automatic changes to the power level of the device to ensure it only uses the minimum level required to reach the network.

The World Health Organization has stated that present scientific information does not indicate the need for any special precautions for the use of mobile devices. They note that if you want to reduce your exposure then you can do so by limiting the length of calls or using a 'hands-free' device to keep the mobile phone away from the head and body.

-
- * The tests are carried out in accordance with international guidelines for testing.
 - ** Please see the CONDITIONS OF USE section on page 122 about body worn operation.

INFORMATION ON PROPER DISPOSAL



Attention: Your product is marked with this symbol. It means that used electrical and electronic products should not be mixed with general household waste. There is a separate collection system for these products.

A. Information on Disposal for Users (private households)

1. In the European Union

Attention: If you want to dispose of this equipment, please do not use the ordinary dust bin!

Used electrical and electronic equipment must be treated separately and in accordance with legislation that requires proper treatment, recovery and recycling of used electrical and electronic equipment.

Following the implementation by member states, private households within the EU states may return their used electrical and electronic equipment to designated collection facilities free of charge*. In some countries* your local retailer may also take back your old product free of charge if you purchase a similar new one.

*) Please contact your local authority for further details.

If your used electrical or electronic equipment has batteries or accumulators, please dispose of these separately beforehand according to local requirements.

By disposing of this product correctly you will help ensure that the waste undergoes the necessary treatment, recovery and recycling and thus prevent potential negative effects on the environment and human health which could otherwise arise due to inappropriate waste handling.

2. In other Countries outside the EU

If you wish to discard this product, please contact your local authorities and ask for the correct method of disposal.

For Switzerland: Used electrical or electronic equipment can be returned free of charge to the dealer, even if you don't purchase a new product. Further collection facilities are listed on the homepage of www.swico.ch or www.sens.ch.

B. Information on Disposal for Business Users.

1. In the European Union

If the product is used for business purposes and you want to discard it:

Please contact your SHARP dealer who will inform you about the take-back of the product. You might be charged for the costs arising from take-back and recycling. Small products (and small amounts) might be taken back by your local collection facilities.

For Spain: Please contact the established collection system or your local authority for take-back of your used products.

2. In other Countries outside the EU

If you wish to discard of this product, please contact your local authorities and ask for the correct method of disposal.

PRECAUTIONS FOR USE IN USA

Changes or modifications not expressly approved by the manufacturer responsible for compliance could void the user's authority to operate the equipment.

Exposure to Radio Waves

THIS MODEL PHONE MEETS THE GOVERNMENT'S REQUIREMENTS FOR EXPOSURE TO RADIO WAVES.

Your wireless phone is a radio transmitter and receiver. It is designed and manufactured not to exceed the emission limits for exposure to radio frequency (RF) energy set by the Federal Communications Commission of the U.S. Government. These limits are part of comprehensive guidelines and establish permitted levels of RF energy for the general population. The guidelines are based on standards that were developed by independent scientific organizations through periodic and thorough evaluation of scientific studies. The standards include a substantial safety margin designed to assure the safety of all persons, regardless of age and health.

The exposure standard for wireless mobile phones employs a unit of measurement known as the Specific Absorption Rate, or SAR. The SAR limit set by the FCC is 1.6 W/kg.* Tests for SAR are conducted using standard operating positions specified by the FCC with the phone transmitting at its highest certified power level in all tested frequency bands. Although the SAR is determined at the highest certified power level, the actual SAR level of the phone while operating can be well below the maximum value. This is because the phone is designed to operate at multiple power levels so as to use only the power required to reach the network. In general, the closer you are to a wireless base station antenna, the lower the power output.

Before a phone model is available for sale to the public, it must be tested and certified to the FCC that it does not exceed the limit established by the government-adopted requirement for safe exposure. The tests are performed in positions and locations (e.g., at the ear and worn on the body) as required by the FCC for each model. The highest SAR value for this model phone when tested for use at the ear is 0.355 W/kg and when worn on the body, as described in this user guide, is 0.426 W/kg. Body-worn Operation; This device was tested for typical body-worn operations with the back of the phone kept 1.5 cm from the body. To maintain compliance with FCC RF exposure requirements, use accessories that maintain a 1.5 cm separation distance between the user's body and the back of the phone. The use of belt-clips, holsters and similar accessories should not contain metallic components in its assembly.

The use of accessories that do not satisfy these requirements may not comply with FCC RF exposure requirements, and should be avoided. While there may be differences between the SAR levels of various phones and at various positions, they all meet the government requirement for safe exposure.

The FCC has granted an Equipment Authorization for this model phone with all reported SAR levels evaluated as in compliance with the FCC RF emission guidelines. SAR information on this model phone is on file with the FCC and can be found under the Display Grant section of <http://www.fcc.gov/oet/fccid> after searching on FCC ID APYHRO00041.

Additional information on Specific Absorption Rates (SAR) can be found on the Cellular Telecommunications & Internet Association (CTIA) web-site at <http://www.phonefacts.net>.

* In the United States and Canada, the SAR limit for mobile phones used by the public is 1.6 watts/kg (W/kg) averaged over one gram of tissue. The standard incorporates a substantial margin of safety to give additional protection for the public and to account for any variations in measurements.

Specifications and Optional Accessories

Specifications

Weight:	Approximately 148 g (with battery)
Dimensions (W × H × D):	Approximately 50.0 × 108.7 × 28.5 mm (when closed, without protruding parts)
Battery:	Lithium-Ion, 3.7 V, 900 mAh

Optional Accessories

- Lithium-Ion Battery (XN-1BT70)
- Cigarette Lighter Charger (XN-1CL30)
- USB Data Cable (XN-1DC30)
- AC Charger (XN-1QC30, XN-1QC31)
- External Antenna Cable (XN-1AT90)
- Audio Remote-Controller (XN-1AR90)
- Car Holder (XN-1CH91)
- Desktop Holder (XN-1DH91)
- Stereo Headset (XN-1HS90)
- Handsfree Microphone Unit (XN-1HU90)
- Video Cable (XN-1VC90)

The above accessories may not be available in all regions.
For details, please contact your dealer.

Index

A

Alarms 83
Area Info 59

B

Battery 11
Battery Level Indicator 13
Bluetooth Wireless Function 111

C

Calculator 84
Calendar 80
Call Costs 110
Call Log 109
Call Settings 102
Call Timers 109
Camera (photo/video) 41
 Adjusting the Exposure 43
 Common Shortcut Keys 45
 Continuous Shoot 46
 Focus Setting 44
 Recording Video Clips 42
 Selecting the Picture or Video Quality 44
 Selecting the Picture Size 45
 Selecting the Recording Time and Size 47
 Selecting the Scene 46
 Selecting the Shutter Sound 47
 Switching between the Photo and Video Camera Modes 44
 Taking Pictures 41

Cell Broadcasts 58
Characters 29
 Changing the Input Mode 30
 Using Templates 31
Connectivity 111
 Bluetooth 111
 Flight Mode 115
 Infrared 113
 Internet Settings 115
 Network Settings 114
Contacts List 34
 Contact Groups 38
 Management Category 37
 Memory Status 39
 Selecting the Storage Memory 34
 Speed Dial List 39
 Synchronising Contacts List Entries with those on the Internet 40
 Viewing My Contact Details 35
Contacts Lock 108
Countdown Timer 90

D

Data Counter 109
Date & Time 100
Display Position 17
Display Settings 97

E

Earpiece Volume 22
E-Book 87

Emergency Calls 20
Expenses Memo 90

F

Function Lock 108

G

Games & Applications 72
 Java™ Information 76
 Setting Permission 73
 Switching the Screensaver On or Off 75
 Viewing Application Information 74

H

Handset Code 108
Handset Lock 107

I

In Call Menu (Video Call) 26
 Changing the Image of Yourself 26
 Muting the Microphone 26
 Swapping Images 26
 Turning the Speakers On and Off 27
 Using the Optical Zoom Function 27
 Video Call Settings 27
In Call Menu (Voice Call) 22
 Accessing SMS/MMS Menu during a Call 23
 Conference Call 23
 Muting the Microphone 24
 Putting a Call on Hold 23
 Turning the Speakers On and Off 22

International Calls 20
Internet Settings 115

K

Keypad Lock 15

L

Language Setting 101

M

Master Reset 108

Memory Card 116

Messaging (SMS/MMS/Email) 49

 Calling the Phone Number 53

 Downloading 53

 Email Settings 58

 Forwarding 54

 General Settings 56

 Locking or Unlocking 54

 MMS Settings 57

 Sending a Message in the Drafts Box 52

 Sending a Voice Clip Message or Video
 Clip Message 52

 Sending with Postcard 54

 SMS Settings 57

 Storing the Phone Number 53

 Using the Sending Options 51

Music Player 63

My Items 65

N

Navigating Functions 19

Network Settings 114

O

Organiser & Tools 80

Other Documents 67

P

PC Connection 118

Phone Help 91

Pictures 65

PIN Code 107

PIN2 Code 107

Power On and Off 15

Profiles 93

R

Redialling 21

S

Safety Precautions 122

Scanner 86

Screensavers 75

Secret Data 108

Security 107

Settings 93

SIM Application 92

SIM Card 11

Sound Settings 100

Sounds & Ringtones 66

Speed Dialling 21

Stopwatch 88

T

Tasks 88

Text Templates 71

Troubleshooting 120

V

Video Call Settings 27

Video Clips 67

Vodafone live! 60

Voice Recorder 85

W

WAP Browser 61

World Clock 90

List of Menu Functions

Menu No./Main Menu	Menu No./Sub Menu1
1 Entertainment	1 Games & Applications 2 TV & Video
2 Vodafone live!	1 Vodafone live! 2 Enter URL 3 Bookmarks 4 Alert Inbox 5 My Saved Page 6 Access History 7 Browser Settings 8 What's New? 9 Music* 10 Games 11 Ringtones 12 Pictures 13 News 14 Sport
3 Music	1 Last Played Music/Currently Playing 2 My Music 3 Browse Music Store*
4 Messaging	1 Create Message 2 Inbox 3 Drafts 4 Sent 5 Outbox 6 Vodafone Messenger 7 Templates 8 Media Album* 9 Messaging Settings 10 Memory Status

*This menu is not available with some service providers.

Menu No./Main Menu	Menu No./Sub Menu1
5 Camera	
6 My Items	1 Pictures 2 Sounds & Ringtones 3 Games & Applications 4 Videos 5 Text Templates 6 Other Documents 7 Memory Status
7 Organiser & Tools	1 Calendar 2 Alarms 3 Calculator 4 Voice Recorder 5 Scanner 6 E-Book 7 Stopwatch 8 Tasks 9 World Clock 10 Countdown Timer 11 Expenses Memo 12 Phone Help
8 Contacts	1 Contacts List 2 Call Voicemail 3 Manage Category 4 Speed Dial List 5 My Contact Details 6 Contact Groups 7 Synchronise 8 Settings 9 Manage Contacts

Menu No./Main Menu	Menu No./Sub Menu1
9 Call Log	1 All Calls
	2 Dialed Numbers
	3 Missed Calls
	4 Received Calls
	5 Call Timers
	6 Data Counter
	7 Call Costs**
10 Connectivity	1 Bluetooth
	2 Infrared
	3 Network Settings
	4 Flight Mode
	5 Internet Settings
	6 Memory Card
11 SIM Application	
12 Settings	1 Profiles
	2 Display Settings
	3 Sound Settings
	4 Date & Time
	5 Language
	6 Call Settings
	7 Video Call Settings
	8 Security
	9 Master Reset

**Depends on SIM card contents.

Note for the menu indications for the Postcard, Media Album and other services

- The menu indications for the Postcard, Media Album and other services vary in the United Kingdom and Ireland as follows:

Current indications in the user guide	Indications in United Kingdom	Indications in Ireland
"Postcard"	"live! Postcard"	(Not available)
"Additional Information"	"Additional information"	"Additional Information"
"Street & Number"	"Address"	"Street & Number"
"State/Province"	"County"	"State/Province"
"Postal Code"	"Post Code"	"Postal Code"
"Media Album"	"live! Studio"	"Picture Album"
"To Media Album"	"To live! Studio"	"To Picture Album"
"What's New?"	"New"	"New"