

# Getting Started

<b>Handset Parts</b> .....	<b>1-2</b>	<b>Codes</b> .....	<b>1-21</b>
Basic Key Operations .....	1-3	Security Code .....	1-21
<b>Display</b> .....	<b>1-6</b>	Center Access Code .....	1-21
Display Indicators .....	1-6	Network Password .....	1-21
External Display Indicators .....	1-8	<b>Other Basic Information</b> .....	<b>1-22</b>
Switching Display Views .....	1-9	Checking Battery Level .....	1-22
Mobile Widget (Japanese) .....	1-9	My Phone Number .....	1-22
<b>USIM Card</b> .....	<b>1-11</b>	Checking Network Status .....	1-22
Before Using USIM Card .....	1-11	Key Illumination .....	1-22
Other Notes on USIM Cards .....	1-11	Stereo Earphone Conversion Cable .....	1-23
USIM PINs .....	1-12	Side Key Guard .....	1-23
USIM Card Installation .....	1-13	Using ECO Mode .....	1-23
<b>Battery &amp; Charger</b> .....	<b>1-14</b>		
Notes on Charging Battery .....	1-14		
Battery Installation .....	1-14		
Charging Battery .....	1-16		
<b>Power On/Off</b> .....	<b>1-18</b>		
Power On .....	1-18		
Power Off .....	1-18		
<b>Mobile Manners</b> .....	<b>1-20</b>		
Activating Manner Mode .....	1-20		









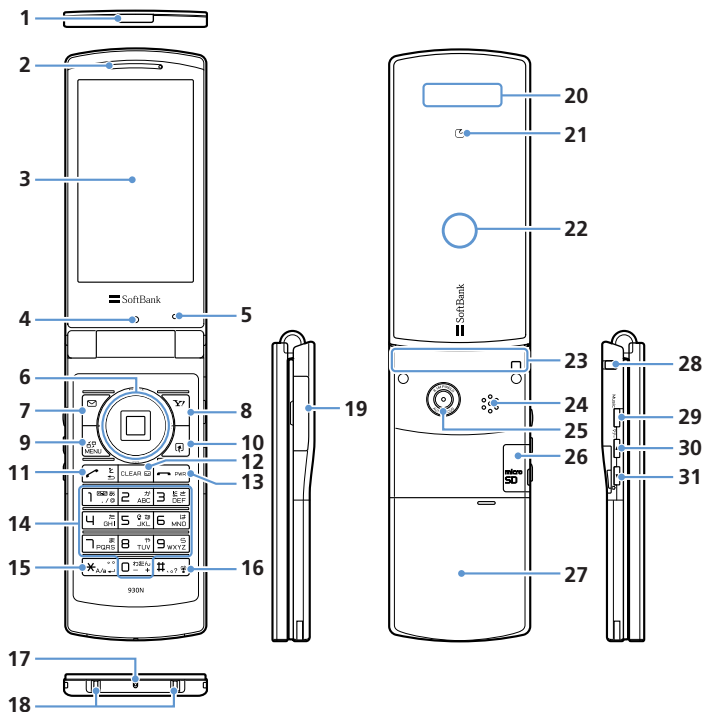



# 1

# Handset Parts

1

Getting Started



- 1 Infrared Port
- 2 Earpiece
- 3 Display
- 4 Front Camera
- 5 Light Sensor
- 6 Multi Selector  & 
- 7 Mail Key 
- 8 Yahoo! Keitai Key 
- 9 Menu Key 
- 10 Shortcut Key 
- 11 Send Key 
- 12 Clear/Back Key 
- 13 Power/End Key 
- 14 Keypad 
- 15 \*Key 
- 16 #/Manner Key 
- 17 Microphone
- 18 Charger Terminals
- 19 External Device Port
- 20 Indicator Display (External Display)
- 21 FeliCa Mark
- 22 Charging Indicator/Illumination
- 23 Internal Antenna<sup>1</sup>
- 24 Speaker
- 25 Rear Camera
- 26 Memory Card Slot
- 27 Battery Cover
- 28 Strap Eyelet

29 Music Key  <sup>2</sup>

30 Volume up/Manner Key  <sup>2</sup>

31 Volume down/Camera Key  <sup>2</sup>















- For optimal signal reception, do not cover Internal Antenna with hands or anything else. Do not put stickers over Internal Antenna.
- Key illustrations are simplified and differ in appearance from actual handset keys.

## Tip

- TV antenna is built into handset (Handset acts as a TV antenna).

## Basic Key Operations

### In Standby











No.	Key/Operations	Description
6		Access widgets.
	Press and hold 	Open S! Quick News List.
		Open Phone Book Search menu.
		Open Received Calls window.
	Press and hold 	Open Received Address List.
		Open Redial window.
	Press and hold 	Open Sent Address List.
7		Open Mail menu.
	Press and hold 	Compose a new message.
8		Access Yahoo! Keitai portal.
	Press and hold 	Open Yahoo! Keitai menu.
9		Open Main Menu.
10		Activate function assigned to key.
	Press and hold 	Assign a function to key.
11		Open Tomo-Den Window.





No.	Key/Operations	Description
12		Play messages on Answering Machine.
	Press and hold	Set/cancel Answering Machine.
13		Show/hide Desktop Page.
	Press and hold	Turn power on/off.
14	Press and hold	Display current location using GPS function.
	Press and hold	Set/cancel IC Card Lock.
	Press and hold	Set/cancel ECO Mode.
	Press and hold	Set font type, thickness and size.
	Press and hold	Set Privacy Angle on/off.
	Press and hold	Enter “+” (international access code).
16	Press and hold	Set/cancel Manner Mode.
29		Open Original Menu. Check missed calls (with handset closed).
	Press and hold	Activate Music Player.
30	Press and hold	Set/cancel Manner Mode.
31		Check new messages. View Clock when there are no missed calls or new messages (with handset closed).
	Press and hold	Activate Camera in Photo Mode.

## During Voice Calls

No.	Key/Operations	Description
6		Open Phone Book Search Group menu.
	Press and hold	Continuously increase earpiece volume.
		Open Phone Book Search Column menu.
	Press and hold	Continuously decrease earpiece volume.
		Open Received Calls window.
		Open Redial window.
7		Turn handsfree on/off.
8		Toggle Hyper Clear Voice modes (High, OFF or Low).
9		Open Task Switch window.
10		Display function menu.
12		Hold call.
13		End call.
	Press and hold	Turn power off.
16	Press and hold	Set/cancel Manner Mode.
30		Increase earpiece volume.
31		Decrease earpiece volume.
	Press and hold	Record other party's voice

## During Text Entry







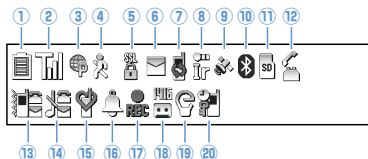











No.	Key/Operations	Description
6		Insert line feed "↵" (when cursor is at the end of text).
		Add a space (when cursor is at the end of text).
7		Toggle character entry modes (in 5-touch or T9 input mode). Toggle double-byte and single-byte characters (in 2-touch mode).
	Press and hold 	Toggle text input methods (in 5-touch, 2-touch or T9 input mode).
8		Switch to pictograph/symbol list.
	Press and hold 	Access My Pictograms (in S! Mail).
11		Cycle characters in reverse order (in 5-touch mode).
	Press and hold 	Undo last operation (conversion, pasting, cut, etc.) and return to the previous state.
12		Delete one character to right of cursor. When cursor is at end of text, a character to left is deleted.
	Press and hold 	Delete all text to right of cursor. When cursor is at end of text, delete all text.





No.	Key/Operations	Description
15		Enter dakuten (゛) or handakuten (゜) (in 5-touch or 2-touch mode). Toggle case (in 5-touch or 2-touch mode). Insert line feed "↵".
	Press and hold 	Select area.
16		Toggle Shift, Caps Lock and lower case modes (when entering alphanumerics in T9 input mode).
	Press and hold 	Paste copied or cut text.

## Display Indicators







- ① Battery Level
  - Temperature Warning
- ② Signal Strength  
**OUT** Out of Range
  - Emission OFF Mode
  - USIM Lock Active
- ③ Yahoo! Keitai Mode
  - Yahoo! Keitai Communication in Progress
  - Packet Transmission (No Data Transfer)
  - Connecting to Network for Packet Transmission
    - Packet Transmission (Sending/Receiving Data)
- ④ Pedometer ON
- ⑤ SSL Secured Site Connected
- ⑥ Unread Messages
  - Handset Message Memory Full
  - USIM SMS Memory Full ( when there are unread messages)
  - Handset & USIM SMS Memory Full
- ⑦ Software Updated
  - Side Key Guard On
  - IC Card Lock Active
  - Side Key Guard & IC Card Lock Settings
- ⑧ Infrared Transmission
  - Authenticating IC Card
  - S! Addressbook Back-up Synchronizing
  - Dial Lock Active
  - Original Lock Active
  - Secret Mode/Secret Data Only Mode
  - Original Lock Active in Secret Mode/Secret Data Only Mode
- ⑨ GPS Tracking
- ⑩ (Blue) Bluetooth Communication in Progress
  - (Black) Bluetooth Power Saving
  - Bluetooth Call
- ⑪ Memory Card Inserted
  - Invalid Memory Card Inserted
  - Memory Card Reader/Writer in Use
  - Accessing Memory Card
- ⑫ Voice Call
  - Video Call
  - Maximum Call Cost Limit Reached
  - USB Cable Connected in Communication, microSD or MTP Mode
    - microSD/MTP Mode
    - Handsfree Device Connected in Communication, microSD or MTP Mode
    - USB Cable & Handsfree Device Connected in Communication, microSD or MTP Mode
- ⑬ Vibration Set for Incoming Calls & Messages
  - Vibration Set for Incoming Calls/Messages
- ⑭ No Ringtone for Incoming Calls & Messages
  - No Ringtone for Incoming Calls/Messages
- ⑮ Manner Mode
  - Auto Manner Mode Start On
  - Auto Manner Mode Release On

- 16  Alarm Set
  -  Alarm Set for Today (appears prior to set time.)
- 17  One Seg Timer Recording in Progress
- 18  New Messages at Voice Mail Center
  -  Answering Machine On
    -  New Voice Calls
    -  New Video Calls
    -  New Voice & Video Calls
  -  Auto Voice Memo On
    -  New Auto Voice Memos
  -  Answering Machine & Auto Voice Memo On
    -  New Voice Calls
    -  New Video Calls
    -  New Auto Voice Memos
    -  New Voice & Video Calls
    -  New Voice Calls & Auto Voice Memos
    -  New Video Calls & Auto Voice Memos
    -  New Voice & Video Calls, Auto Voice Memos

- 19  ECO Mode
  -  Privacy Angle On (  when Backlight is Off)
- 20  Keypad Lock Active (*After Closed* or *Timer is ON*)

## Tip

- To see indicator descriptions:

 ⇨ *Settings* ⇨  ⇨ *Display* ⇨  ⇨ *Icons* ⇨ 

## External Display Indicators



- 1 Battery Level
- 2 Unread Messages
  - Handset Message Memory Full
  - USIM SMS Memory Full  
( when there are unread messages)
  - Handset & USIM SMS Memory Full
- 3 Manner Mode
- 4 Voice Call
  - Video Call
- 5 Yahoo! Keitai Mode
  - Yahoo! Keitai Communication in Progress
  - Packet Transmission (Sending/Receiving Data)
- 6 Signal Strength
  - Out of Range
  - Emission OFF Mode

## Animation

Handset status and new information appear on External Display.

## Examples



Clock (Digital 1)



Alarm notification



Receiving call



Missed call/  
New mail



On hold



Timer recording  
notification



Emotion-Expressing  
Mail



IC card  
authentication

## Tip

- External Display is sometimes hard to view outdoors or under strong lighting.



## Switching Display Views

Display automatically changes to Landscape View when turned on its left side.

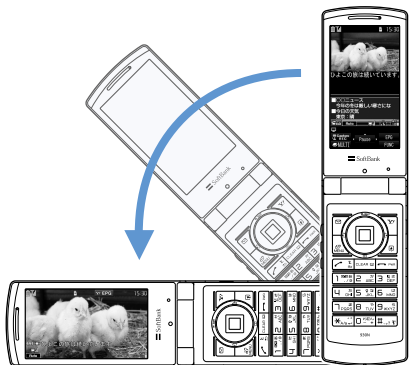

### Tip

- Landscape View is available for Camera, TV and file playback (My Picture, Videos or TV). Display remains in Portrait View in ECO Mode.
- Landscape View is also possible by turning handset on its right side while watching TV or playing recorded programs.

## Mobile Widget (Japanese)

Set Widgets to appear on Desktop.

- For information about Mobile Widget, see P. 10-2.



Add Widgets Here

Use Pointer to select widget

Desktop Page

### Tip

- Flash® wallpaper pauses when accessing widgets. Open any function before returning to Standby and Flash® resumes.

## More Features

### Customize

#### Style Mode Settings

- Set Display Design Collectively
- Check Default Style Mode Settings
- Edit Title of a Style
- Save Current Style Mode Settings as Favorite
- Change Each Item for Favorites
- Clear All Favorite Settings

#### Display Settings

- Wallpaper
- Show Calendar in Standby
- Set Random Display of Images in Standby
- Display Color Scheme
- Set a Battery Level Indicator/Signal Strength Indicator Pattern
- Interface Language
- Set Auto-change Screen
- Guard from Prying Eyes
- Set 3D Effect When Returning to Standby
- Display Quality

#### Backlight

- Set Backlight & Power Saving
- Set Brightness of Backlight

(▶ P. 14-3)

(▶ P. 14-3)

(▶ P. 14-5)

#### Standby Indicators

- Enable Indicator Selector

(▶ P. 14-7)

#### Indicator Display

- Set Only Clock to Appear
- Set Clock Pattern
- Set Messages to Appear
- Set Clock to Appear at Specified Time
- Set Viewable Time

(▶ P. 14-7)

#### Closed Illumination

- Set Flashing Color for Handset Close
- Set Flashing Pattern for Handset Close

(▶ P. 14-27)

#### Key Backlight

- Set Key Backlight Color

(▶ P. 14-28)

## Before Using USIM Card

Universal Subscriber Identity Module (USIM) Card is an IC card that contains customer information (phone number, etc.). A USIM Card must be inserted to use your handset.

- Store Phone Book entries and SMS on USIM Card.
- Insert USIM Card into other USIM-compatible SoftBank handsets to use information on Card.
- Do not apply excessive force when inserting/removing USIM Card.
- SoftBank is not liable for any damage caused by inserting USIM Card into other IC card readers/writers.
- USIM Card may become warm during use. This is not a malfunction.
- Keep IC chip clean.
- For details, refer to the manual supplied with your USIM Card.
- Do not drop USIM Card or subject to excessive shock. Doing so may cause malfunction.
- Do not bend USIM Card or place heavy objects on it. Doing so may cause malfunction.
- Avoid extreme temperatures.
- Do not scratch, carelessly touch or short-circuit the IC chip. Doing so may result in data loss or malfunction.
- Clean USIM Card with a dry soft cloth (such as is used for eyeglasses).
- Use a SoftBank-designated USIM Card. Using a non-designated card may result in handset malfunction.

## Other Notes on USIM Cards

- USIM Cards are the property of SoftBank.
- USIM Cards will be reissued for a fee if lost or damaged.
- Return USIM Cards to SoftBank upon cancellation or suspension of service.
- Returned USIM Cards are recycled.
- USIM Card specifications and performance may change without prior notice.
- Keep a separate copy of data saved on your USIM Card. SoftBank is not liable for lost data.
- If USIM Card or handset (with USIM Card inserted) is lost or stolen, suspend service immediately. For details, contact SoftBank Mobile Customer Center, General Information (P. 15-53).
- Downloaded files (S! Appli, videos, Saved Pages, etc.) saved to handset or memory card may be inaccessible after USIM Card replacement, handset upgrade or service subscription cancellation. If a different USIM Card is inserted, the cookies and cache are cleared to protect personal information.

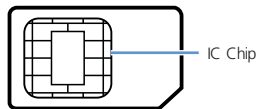

## USIM PINs

There are two security codes for USIM Cards: PIN1 and PIN2.

### PIN1

PIN1 is a four- to eight-digit code to prevent unauthorized handset use by a third party.

- Default PIN1 is 9999.
- PIN1 can be changed (P. 4-2).
- When *PIN1 Code Entry Set* is set to *ON*, PIN1 must be entered each time handset is turned on to be used.

### PIN2

PIN2 is required to reset total call cost or to set a maximum limit to call costs.

- Default PIN2 is 9999.
- PIN2 can be changed (P. 4-2).

### PIN Lock & Cancellation (PUK)

If PIN1 or PIN2 is incorrectly entered three times consecutively, PIN Lock is activated, limiting handset use to specific functions. Enter Personal Unblocking Key (PUK1/PUK2) to cancel PIN Lock.

- For information on PUK, contact SoftBank Mobile Customer Center, General Information (P. 15-53).

## Note

- If PIN1 is incorrectly entered three times, and then PUK is incorrectly entered 10 times, USIM Card locks and handset cannot be used.
- If PIN2 is incorrectly entered three times, and then PUK is incorrectly entered 10 times, operations that require PIN2 will become unusable.
- Write down your PUK.
- To cancel USIM Card lock, contact SoftBank Mobile Customer Center, General Information (P. 15-53).

## USIM Card Installation

- Remove Battery (P. 1-15) before inserting or removing USIM Card.

### Insertion

- 1 Slide in USIM Card (IC chip facing down)

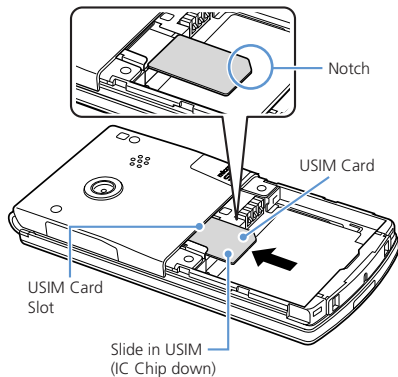

- 2 Push USIM Card in completely

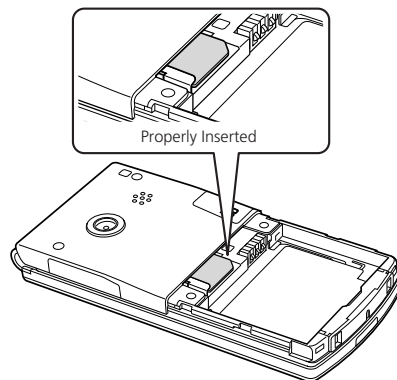

### Removal

- 1 Slide USIM Card out gently

## Notes on Charging Battery

- Charge battery at least once every six months. If battery is left uncharged for a long period, it may become unusable or its operation time may decrease.
- Avoid connecting too many things to one AC outlet. Doing so may cause the AC outlet to overheat and cause a fire.
- Battery and AC Charger may become warm during charging, but this is not a malfunction. If they become too hot, however, stop charging and contact SoftBank Mobile Customer Center, Customer Assistance (P. 15-53).
- If Charging Indicator flashes red during charging, battery may be faulty. Contact SoftBank Mobile Customer Center, Customer Assistance (P. 15-53).
- Depending on the conditions of usage, the battery may expand as it nears the end of its life. However, this presents no safety problems.
- Check the battery type on its label:

Mark	Type
Li-ion00	Lithium-ion battery Lithium-ion batteries are a recyclable resource. Do not dispose of them as municipal waste. Bring used batteries to your nearest SoftBank Shop or recycling center after insulating the terminals with tape. Observe local regulations on battery disposal.



## Battery Installation

### Insertion

- 1 Press and slide battery cover off

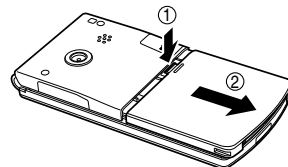

- 2 Insert battery into place

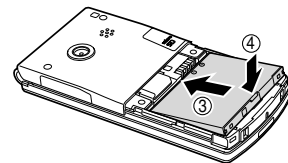

# Battery & Charger

## 3 Replace cover

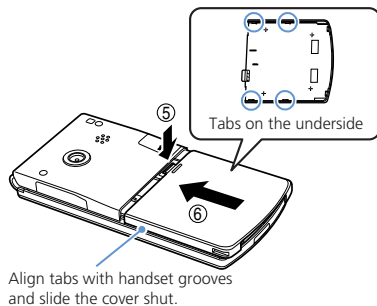

### Note

- Do not force Battery Cover shut. Tab may be misaligned and cause breakage.

## Removal

- Turn off handset before removing battery.

### 1 Remove battery cover

### 2 Pressing Tab (①), lift out battery (②)

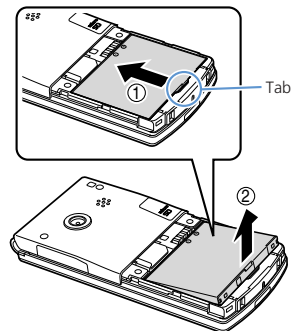

1

Getting Started

## Charging Battery

### Using AC Charger

Use only SoftBank-specified AC Charger (ZTDAA1, sold separately).

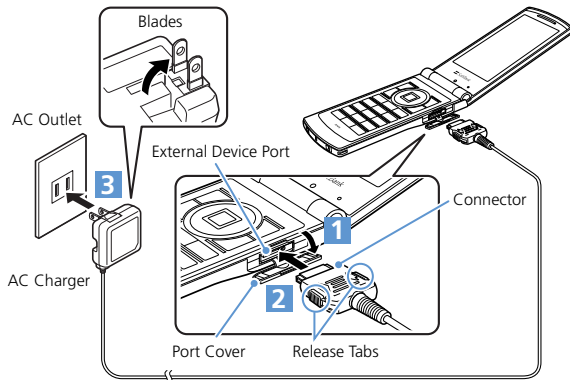

**1** Open Port Cover

**2** Insert Charger connector into External Device Port

**3** Extend Charger blades and plug into an AC Outlet

Charging Indicator lights red while charging. When charging is complete, Indicator goes out.

**4** Disconnect connector from handset

Press and hold Release Tabs to remove connector.

**5** Unplug Charger from AC Outlet

**6** Close Port Cover



# Battery & Charger

## Using Desktop Holder

Desktop Holder is sold separately.

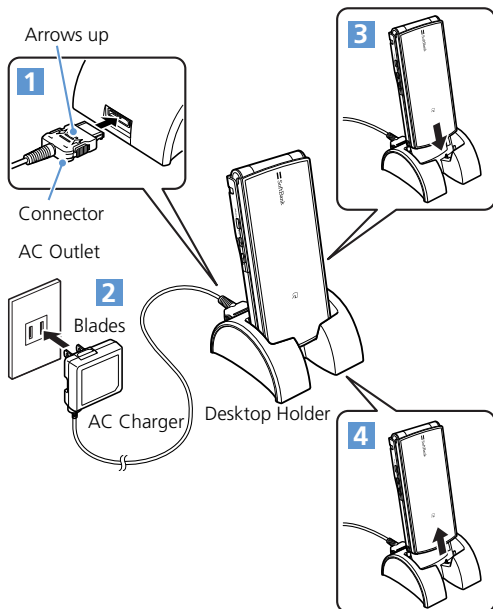

**1** Insert Charger connector into Desktop Holder



**2** Plug Charger into an AC Outlet

**3** Place handset in Desktop Holder

Charging Indicator lights red while charging. When charging is complete, Indicator goes out.

**4** Lift out

### Note

- Battery can only be charged while inserted in handset.
- When both Charging Indicator and Display Indicator  go out and **Charge Unusual Stop Charge** appears, disconnect handset from AC Charger and remove battery. Set up handset and Charger and start charging again. If the same error occurs, AC Charger may be faulty. Contact SoftBank Mobile Customer Center, Customer Assistance (P. 15-53).
- When both Charging Indicator and Display Indicator  flash, handset temperature is unsuitable for charging (Temperature Warning). Wait until handset cools down.

## More Features

### Customize

#### Backlight

- Set Backlight during Charging

[▶ P. 14-5](#)

#### Sounds

- Set to Play Charging Start/End Tones

[▶ P. 14-10](#)

1

Getting Started

## Power On

- Make sure USIM Card is correctly inserted before turning power on.

### 1 Press and hold



### Tip

- Power-on message (WELCOME) may appear on Display for a while when turning on handset immediately after turning power off or inserting battery.
- After USIM Card is replaced, Security Code is required when powering handset on for the first time. If Security Code is incorrectly entered five times, handset shuts down. Turn handset on again.

## Powering Handset On for the First Time (Initial Setup)

Setup prompt appears in Japanese. Select **NO** and press  to exit.

Change interface language to English (P. 14-5) and restart handset to perform setup as follows.

### 1 [Initial Settings] window **YES**



#### ▶ To Automatically Enter Date & Time **Auto** Select a time zone



#### ▶ To Manually Enter Date & Time **Manual (Date Time Set)**

Select a time zone    Enter date and time 

### 2 Enter Security Code (9999)

 Enter new Security Code  

 **YES**  

### 3 Select a font size

Select **Separate Setting** to customize font per window (P. 14-4).



### 4 [Keypad Sound Setting] window

 **ON or OFF**  













### Tip

- Setup prompt no longer appears after setup is complete.
- The default Security Code is 9999.

## Retrieving Network Information

When ,  or , is pressed after initial setup, a prompt appears. Select **YES** to update network settings.

### Tip

- Retrieve network information to use network-related services, such as mail and the Internet.
- To manually update network settings:  
  **Settings**    **Connection Settings**    **Retrieve NW Info**    **YES**  

## Power Off

### 1 Press and hold

Handset shuts down.

## More Features

### Customize

#### Clock

- Hide Clock
- Clock Size
- Clock Color
- Set Auto Time Adjustment
- Manually Adjust Time
- Summer Time
- Time Zone (Sub Clock)
- Hide Sub Clock
- Summer Time (Sub Clock)
- Time Zone Major City (Sub Clock)

[▶ P. 14-2](#)

#### Auto Power On/Off

- Set Auto Power On/Off

[▶ P. 14-3](#)

#### Display Settings

- Set a Wake-up Image
- Set a Wake-up Message
- Set Font Type
- Set Font Thickness
- Set Font Sizes Collectively
- Set Font Size for Each Function Window

[▶ P. 14-3](#)

#### Sounds

- Set Key Sound Off
- Set Handset Open/Close Sound

[▶ P. 14-10](#)

#### Key Illumination

- Set Illumination for Power On/Off

[▶ P. 14-28](#)

#### Resetting Handset

- Reset All Settings to Default
- Initialize Handset to Default Status

[▶ P. 14-30](#)

Use your handset responsibly. Inappropriate handset use can be both dangerous and bothersome. Take care not to disturb others when using your handset. Adjust handset use according to your surroundings.

- Turn handset power off in theaters, museums and other places where silence is the norm.
- Refrain from use in restaurants, lobbies, elevators, etc.
- Observe signs and instructions regarding handset use aboard trains, etc.
- Refrain from use that interrupts the flow of pedestrian or vehicle traffic.

## Activating Manner Mode



Most handset sounds are muted in Manner Mode.

**1** Press and hold 

### Note

- When handset is set to vibrate for incoming calls, be careful as handset may slide off, slide into a stove, etc.
- The other party may hear a short beep if Manner Mode is set or canceled during a call.

### Tip

- Press and hold  again to cancel Manner Mode.
- Shutter click sounds even in Manner Mode.
- Press and hold  to set or cancel Manner Mode during a call. Short beeps sound through the earpiece when Manner Mode is set or canceled during a call.
- Set or cancel Manner Mode by pressing and holding .

## More Features

### Customize

#### Manner Mode

- Set Manner Mode Type
- Configure Original Manner Mode
- Set Time for Auto Manner Mode Start
- Set Time for Auto Manner Mode Release
- Toggle Auto Manner Mode Start and Release On/Off

 **P. 14-9**

Security Code, Center Access Code and Network Password are required to use handset.

- Do not reveal these codes to others. Write down your codes.
- SoftBank is not liable for any damage due to handset misuse.

## Security Code







Security Code, 9999 by default, is required to use some handset functions. The code can be changed.

- If Security Code is entered incorrectly or nothing is entered for 15 seconds, a tone sounds and a message appears. Enter correct Security Code.

### Note

- The warning tone does not sound in Manner Mode or when *Keypad Sound* is set to *OFF*.

## Changing Security Code

- 1  ⇒ **Settings** ⇒  ⇒ **Security** ⇒  ⇒ **Change Security Code** ⇒ 
- 2 Enter current Security Code ⇒ 
- 3 Enter new Security Code ⇒  ⇒ **YES** ⇒ 

## Center Access Code

Center Access Code, a four-digit code assigned at initial subscription, is required to access Optional Services via landlines or to subscribe to fee-based information.

## Network Password

Network Password, a four-digit code assigned at initial subscription, is required to use Call Barring.





- If Network Password is incorrectly entered three times, Call Barring settings are locked. Network Password and Center Access Code must be changed.

## Checking Battery Level

Use Battery Level meters as a guide only.

### Battery Level Indicator

Check the battery level at top of Display or on External Display.

-  81% to 100% Battery Level
-  61% to 80% Battery Level
-  41% to 60% Battery Level
-  21% to 40% Battery Level
-  0% to 20% Battery Level

## Battery Level Beeper & Large Indicator

Check battery level by number of beeps and large indicator.

-   **Settings**    **Other Settings**    **Battery Level**



A large battery level indicator appears. Beeps sound according to the battery level.

Five beeps:

81% to 100% Battery Level

Four beeps:

61% to 80% Battery Level

Three beeps:

41% to 60% Battery Level

Two beeps:

21% to 40% Battery Level

One beep:

0% to 20% Battery Level

### Note

- The battery level beeper does not sound in Manner Mode or when *Keypad Sound* is set to *OFF*.

## When Battery Is Empty

*Recharge Battery* appears, the battery alarm sounds for about 10 seconds, and handset powers off in about 60 seconds. Charge battery.

## My Phone Number

Check handset phone number.











-   

Account Details appear.

### Add Other Information

-    Enter Security Code   
- Select an item    Enter information    

### View All Information

-    **Display All Data**   
- Enter Security Code   
-  to switch tabs

### Reset Account Details

-    **Reset**    Enter Security Code    **YES**  

## Checking Network Status

Check Network Status to confirm if voice calls and/or packet transmission is available.

-   **Settings**    **Other Settings**    **Network Status**  

Network information appears.

## Key Illumination

Key backlight flashes in a variety of patterns.



## Stereo Earphone Conversion Cable

Use Stereo Earphone Conversion Cable (sold separately) to connect earphones.





When sound source is monaural (calls, etc.), stereo earphones output monaural sound to left and right earphones; when sound source is stereo, only the left channel is output to monaural earphones.

## Side Key Guard

Disable Side Keys (, , and ) while handset is closed.



-  → **Press and hold**   
Repeat to cancel setting.

### Tip

- Alternatively, set Side Key Guard by:  
 → *Settings* →  → *Other Settings*  
→  → *Side Key Guard* →  → *ON* or  
*OFF* → 

## Using ECO Mode



When set to ECO Mode, light, sound, and Display settings are modified to decrease battery consumption.

- Press and hold**   
ECO Mode is set, and  appears.

### Note

- ECO Mode is canceled when handset is turned off.
- The other party may hear short beeps if ECO Mode is set or canceled during a call.

### Tip

- Press and hold  again to cancel ECO Mode.
- Press and hold  to set or cancel ECO Mode during a call.

## More Features

### Customize

#### Key Illumination

- Set Illumination for Power On/Off
- Set Illumination for Incoming or Outgoing Calls
- Set Illumination for Call Start
- Set Illumination for Sending/Receiving Messages
- Set Illumination for Emotion-Expressing Mail
- Set Illumination for Alarm Notification
- Set Illumination for Snooze Notification
- Set Illumination for Ir/IC Transmission
- Set Illumination for Missed Call or New Message
- Set Illumination for When Handset Opens
- Set Illumination for Special Events

[▶ P. 14-28](#)

